

Instruction Manual

LXD™ 75-Series Telescopes



MEADE.COM



 **WARNING!**
Never use a Meade® LX D75™-Series Telescope to look at the Sun! Looking at or near the Sun will cause instant and irreversible damage to your eye. Eye damage is often painless, so there is no warning to the observer that damage has occurred until it is too late. Do not point the telescope or its viewfinder at or near the Sun. Do not look through the telescope or its viewfinder as it is moving. Children should always have adult supervision while observing.

CAUTION: Use care to install batteries in the orientation indicated by the illustration in the battery slots of the battery holder. Follow battery manufacturer's precautions. Do not install batteries backwards or mix new and used batteries. Do not mix battery types. If these precautions are not followed, batteries may explode, catch fire, or leak. Improperly installed batteries void your Meade warranty.

CONTENTS

Telescope Features	4
Autostar Features	9
Getting Started	11
Unpacking and Assembly.....	11
How to Assemble Your Telescope	11
Balancing the Telescope	13
Aligning the Viewfinder.....	14
Choosing an Eyepiece.....	14
Observing By Moving the Telescope Manually	15
Activate the Arrow Keys	16
Slew Speeds	16
Observe the Moon	17
Tracking Objects.....	17
Setting the Polar Home Position.....	17
Observe a Star Using Automatic Tracking	18
Using Autostar's GO TO Capabilities	18
Moving Through Autostar's Menu	19
Initializing Autostar	19
Training the Drive	20
Easy Alignment	21
Go To Saturn	21
Using the Guided Tour	22
Basic Autostar Operation.....	23
Autostar Navigation Exercise	23
Entering Data into Autostar	24
Navigating Autostar	24
Autostar's Menus	25
Object Menu.....	26
Event Menu	27
Glossary Menu.....	27
Utilities Menu	27
Setup Menu	28
Useful Autostar Features	32
Adding Observing Sites	32
Using Autostar to Find Objects Not in the Libraries.....	33
Observing Satellites.....	34
Landmarks	34
To Check on Available Memory	35
Photography	36
Optional Accessories.....	37
Maintenance and Collimation	40
Specifications	46
Appendix A: Celestial Coordinates	50
Locating the Celestial Pole.....	51
One- And Two-Star Polar Alignment.....	51
Appendix B: Enhancing Pointing Precision	52
The Polar Alignment Viewfinder	52
Three-Star Alignment Method #1	52
Axis Alignment Method #2	53
Axis Alignment Method #3	55
Smart Drive Training (PEC) Method #4	56
Appendix C: Latitude Chart	57
Appendix D: EC Handbook	58
Appendix E: Mounting the Model SC-8 Optical Tube	62
Appendix F: Basic Astronomy	63

© The name "Meade," "Autostar" and the Meade logo are trademarks registered with the U.S. Patent Office and in principal countries throughout the world. "LXD75," "Autostar Suite," and "LPI" are trademarks of Meade Instruments Corporation.

Patents:
 US 6,304,376
 US 6,392,799
 US 6,563,636
 D 422,610
 Patent Pending

© 2004 Meade Instruments Corporation.

TELESCOPE FEATURES

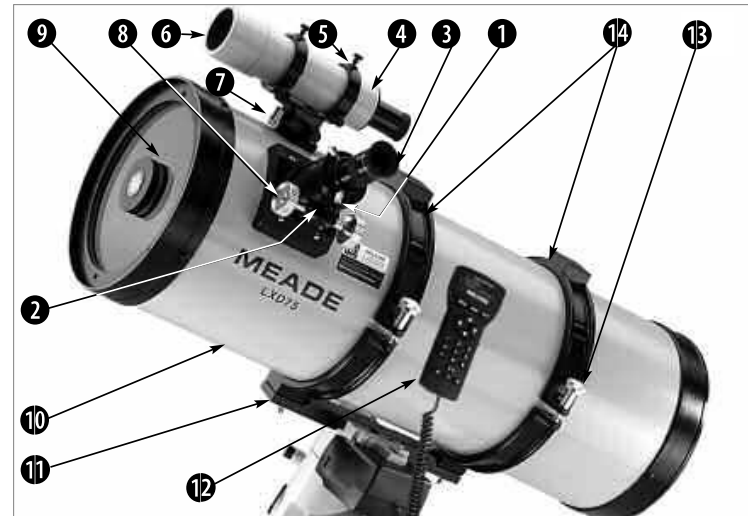

Fig. 1a: The LX D75-Series Telescope Optical Assembly (Schmidt-Newtonian model with Autostar handbox shown; Electronic Controller model users, see Appendix D, page 58).

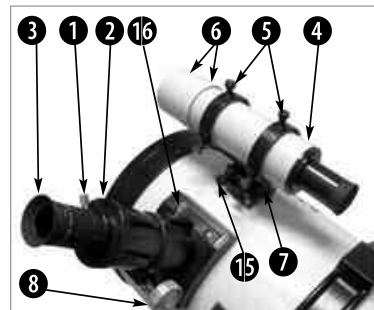

Fig. 1b: Close up of Focuser and Viewfinder Assembly, Schmidt-Newtonian shown. (See Fig. 1a for overview.) For a close up of the refractor focuser assembly, see Fig. 10b, page 13.

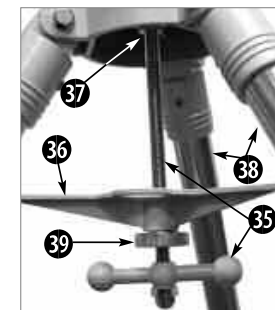

Fig. 1c: The LX D75-Series Tripod.

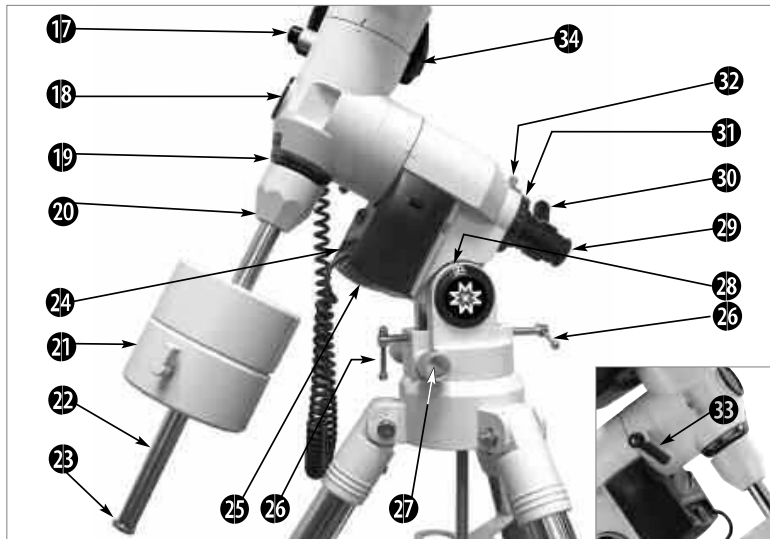

Fig. 1d: The LX75-Series Mount; insert shows opposite side of Mount.

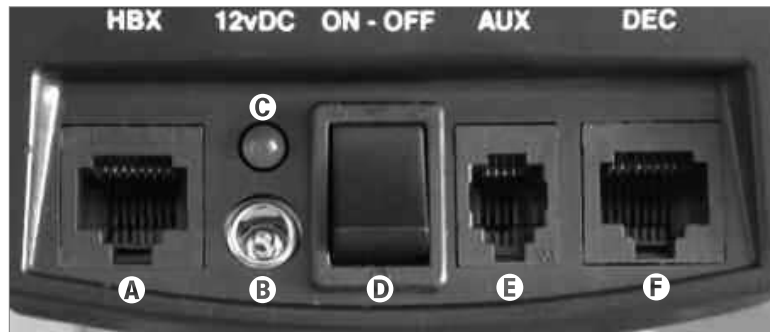

Fig. 1e: The LX75-Series Computer Control Panel (see 10 above).

Legend

- | | | | |
|--------------------------|------------------------------|----------------------------------|-----------------------------------|
| 1. Eyepiece Thumbscrew | 11. Cradle Assembly | 21. Counterweight, Lock Knobs | 31. R.A. Setting Circle |
| 2. Eyepiece Holder | 12. Autostar Handbook | 22. Counterweight Shaft | 32. R.A. Setting Circle Lock Knob |
| 3. Eyepieces | 13. Cradle Ring Lock Knobs | 23. Counterweight Safety Cap | 33. R.A. Lock |
| 4. Viewfinder (VF) | 14. Cradle Rings | 24. Computer Control Panel | 34. Dec. Motor Drive |
| 5. VF Collimation Screws | 15. VF Bracket Screws | 25. R.A. Motor Drive | 35. T-Handle Lock and Shaft |
| 6. VF Front Cell | 16. Focus Lock Knob | 26. Latitude Adjustment Handles | 36. Spreader Bar |
| 7. VF Bracket | 17. Dec. Lock | 27. Azimuth Control Knobs | 37. Tripod Mounting Base |
| 8. Focus Knobs | 18. Polar VF Cap | 28. Latitude Dial | 38. Tripod Legs |
| 9. Corrector/Dust Cover | 19. Dec. Setting Circle | 29. Polar Alignment VF | 39. Spreader Tension Knob |
| 10. Optical Tube | 20. Counterweight Shaft Base | 30. Polar Alignment Reticle, LED | |

Caution: Using products other than standard Meade accessories may cause damage to the telescope's internal electronics and may void the Meade warranty.

3 Want to learn more about the eyepieces available for your LX75-Series telescope? See OPTIONAL ACCESSORIES, page 37.

4 Want to learn more about aligning the viewfinder? See page 14.

7 Want to learn more about attaching the viewfinder? See page 12.

11 Want to learn more about assembling your telescope? See ASSEMBLING YOUR TELESCOPE, page 11.

12 EC Handbook users, see Appendix D, page 58, for more information.

LX75-Series: Your Personal Window to the Universe

The Meade LX75-Series models are versatile, high-resolution telescopes. Supplied with either an Electronic Controller or an Autostar handbox, the LX75-Series models offer unmatched mechanical and electronic performance.

The LX75-Series telescopes reveal nature in an ever-expanding level of detail. Observe the feather structure of an eagle from 50 yards or study the rings of the planet Saturn from a distance of 800 million miles. Focus beyond the Solar System and observe majestic nebulae, ancient star clusters, and remote galaxies. Meade LX75-Series telescopes are instruments fully capable of growing with your interest and can meet the requirements of the most demanding advanced observer.

Refer to Figures 1a through 1e for the following features:

- 1 **Eyepiece Thumbscrew:** Tightens the eyepiece (see 3) in place. Tighten to a firm feel only.
- 2 **Eyepiece Holder:** Holds eyepiece in place. Holders supplied for both 1.25" and 2" eyepieces.
Diagonal (not shown, achromatic refractor and Schmidt-Cassegrain models only): Provides a more comfortable right-angle viewing position. Slide the diagonal directly into the eyepiece holder (see 2) and tighten the thumbscrew on the eyepiece holder to a firm feel only. See page 13 for a photo and more information.
- 3 **Eyepiece:** Place the supplied Super Plössl 26mm eyepiece into the eyepiece holder or the diagonal and tighten in place with the eyepiece thumbscrew (see 1). The eyepiece magnifies the image collected in the optical tube.
- 4 **8 x 50mm (all models, except N-6EC Newtonian) or 6 x 30mm (N-6EC Newtonian only) Viewfinder:** A low-power, wide-field sighting scope with crosshairs that enables easy centering of objects in the telescope eyepiece (see 3).
- 5 **Viewfinder Collimation Screws (6):** Use these screws to adjust the alignment of the viewfinder.
- 6 **Viewfinder Front Cell and Locking Ring:** Adjust the front cell to focus the viewfinder. See step 3, page 14 for more details. The viewfinder is supplied with a small dust cover placed over the front cell.
- 7 **Viewfinder Bracket:** Holds the viewfinder in place.
- 8 **Focus Knobs:** Moves the telescope's focuser drawtube in a finely-controlled motion to achieve precise image focus. The LX75-Series telescopes can be focused on objects from a distance of about 75 ft. to infinity. Rotate the focus knobs to focus on objects.
- 9 **Corrector/Dust Cover:** Place the dust cover (not visible in photo) over the corrector when storing the telescope.
Note: The dust cover should be replaced after each observing session and the power turned off to the telescope. Allow time for any dew that might have collected during the observing session to evaporate prior to replacing the dust cover.
- 10 **Optical Tube:** The main optical component that gathers the light from distant objects and brings this light to a focus for examination through the eyepiece.
- 11 **Cradle Assembly:** Attaches to mount base. See 1 and 10.
- 12 **Autostar™:** See pages 9 and 10 for a description of features.
- 13 **Cradle Ring Lock Knobs (2) and Washers (2):** Slide washers onto lock knobs before inserting. Tighten to a firm feel to secure the optical tube in place.
- 14 **Cradle Rings (2):** Part of the cradle assembly (see 11); hold the optical tube firmly in place.

Caution When loosening the Dec. lock, be sure to support the optical tube (18, Fig. 1a). The weight of the tube could cause the tube to swing suddenly.

- 15 **Viewfinder Bracket Screws:** Tighten to a firm feel to hold viewfinder securely in place (see 4 and 7). See page 12 for more information.
- 16 **Focus Lock Knob:** Designed to prevent the focuser drawtube from moving when a heavy accessory, such as a camera, is attached to the focuser assembly. For normal observing with an eyepiece and diagonal, it is not necessary to use the lock knob.
- 17 **Declination (Dec.):** Controls the manual movement of the telescope. Turning the Dec. lock counterclockwise unlocks the telescope enabling it to be freely rotated by hand about the Dec. axis. Turning the Dec. lock clockwise (to a firm feel only) tightens the lock and prevents the telescope from being moved manually, but engages the Dec. motor drive (see 34) for Autostar operation.
- 18 **Polar Viewfinder Cap:** Remove this cap when using the polar viewfinder (see 20).
- 19 **Dec. Setting Circle:** See APPENDIX A, page 50, for more information.
- 20 **Counterweight Shaft Base:** Thread, along with the shaft, to the mount. See page 11 for more information.
- 21 **Counterweight and Counterweight Lock Knob:** Counterbalances the weight of the optical tube, and adds stability to the mount. Tighten the lock knob on the side of the counterweight to a firm feel to prevent the weight from sliding on the shaft.
- 22 **Counterweight Shaft:** Slide the counterweight onto this shaft (see 41).
- 23 **Counterweight Safety Cap:** Prevents the counterweight from accidentally slipping off the end of the counterweight shaft.
- 24 **Computer Control Panel (see Fig. 1e):**
 - A. **Handbox (HBX) Port:** Plug the Autostar or EC handbox coil cord (10, Fig. 2) into this port.
 - B. **12v DC Power Connector:** Plug the battery pack into this connector. The telescope assembly also may be powered from either a 12v DC auto cigarette lighter plug using the optional #607 Cigarette Lighter Adapter or from a standard 115v AC home outlet using the optional #547 Power Adapter with Cable or #547F Power Adapter for 220v outlets. See OPTIONAL ACCESSORIES, page 38.
 - C. **LED:** Illuminates when power is supplied to the Autostar or EC handbox and the telescope's motor drive.
 - D. **ON/OFF Switch:** Turns the Computer Control Panel and Autostar ON or OFF.
 - E. **AUX Port:** Provides connection for current and future Meade accessories. See OPTIONAL ACCESSORIES, page 38.
 - F. **Dec Port:** Plug the coil cord from the Dec. motor assembly into this port for Autostar to control the motor drive.
- 25 **Right Ascension (R.A.) Motor Drive Assembly:** Controlled by Autostar or EC handbox. Moves the optical tube along the R.A. axis. The R.A. Lock (see 31) must be tightened to a firm feel in order for the R.A. motor to operate.
- 26 **Latitude Adjustment T-Handles (2):** Sets the latitude of your observing location. The two T-handle screws work in a "push - pull" operation—as you tighten one, loosen the other.
- 27 **Fine Azimuth Control Knobs:** Fine tune the side-to-side movement of the telescope when centering Polaris in the telescope eyepiece or when using the polar alignment viewfinder (see 20).
- 28 **Latitude Dial:** Set the latitude of the observing site on this dial using the latitude T-handle screws. For more information see Step 6, page 12.
- 29 **Polar Alignment Viewfinder:** Allows you to precisely polar align the telescope. Useful when performing astrophotography. See page 52.
- 30 **Polar Alignment Viewfinder Reticle and LED Knob:** Rotate the knob to switch on or off the LED that illuminates the reticle within the polar alignment finder. Be

29 Want to learn more about the polar alignment viewfinder? See the *The Polar Alignment Viewfinder*, page 52.



Fig. 1f: The tripod leg lock knob.

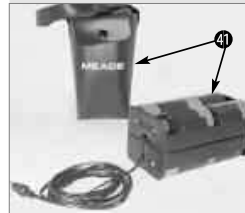

Fig. 1g: The LX D75-Series Battery Pack and holder.

41 Want to learn how to install the batteries? See step 12, page 13.

Caution: Use care to install batteries as indicated by the battery compartment. Follow battery manufacturer's precautions. Do not install batteries backwards or mix new and used batteries. Do not mix battery types. If these precautions are not followed, batteries may explode, catch fire, or leak. Improperly installed batteries void your Meade warranty. Always remove the batteries if they are not to be used for a long period of time.

- sure to turn off the LED when finished with the polar viewfinder. Powered by (factory-supplied) batteries contained within.
- 31 **R.A. Setting Circle:** See APPENDIX A, page 50, for more information.
- 32 **R.A. Setting Circle Lock Knob:** Rotate the knob to lock the R.A. Setting Circle (see 31) in place.
- 33 **R.A. Lock:** Controls the manual movement of the telescope. Turning the R.A. lock counterclockwise unlocks the telescope enabling it to be freely rotated by hand about the R.A. axis. Turning the R.A. lock clockwise (to a firm feel only) tightens the lock and prevents the telescope from being moved manually, but engages the R.A. motor drive (see 25) for Autostar or EC handbox operation.
- 34 **Dec. Motor Drive Assembly:** Controlled by Autostar or the EC handbox. Moves the optical tube along the Dec. axis. The Dec. Lock (see 17) must be tightened to a firm feel in order for the Dec. motor to operate.
- 35 **T-Handle Lock and Shaft:** Place the spreader bar (see 36) over the shaft and thread the shaft into the tripod mounting base/mounting base (see 37) and tighten to a firm feel to secure the tray to the tripod and keep the tripod stable. See HOW TO ASSEMBLE YOUR TELESCOPE, page 11 for more information.
- 36 **Spreader Bar:** Holds the tripod legs securely in place and also acts as a holder for extra eyepieces.
- 37 **Tripod Mounting Base:** Set the telescope mount into the tripod mounting base and secure into place using the T-handle lock and shaft. See HOW TO ASSEMBLE YOUR TELESCOPE, page 11 for more information.
- 38 **Variable Height Tripod Legs (3):** Supports the telescope mount. The mount attaches to the top of the tripod.
- 39 **Spreader Bar Tension Knob:** Tighten to secure the spreader bar (see 36) against the tripod legs.
- 40 **Tripod Leg Lock Knobs (one on each leg):** Loosen these knobs to slide the inner leg extension. Tighten the knobs to a firm feel to lock in the height of the tripod.
- 41 **Battery Pack and holder (see Fig. 1f):** Plug into the 12v DC power connector (B, Fig. 1e) of the computer control panel. Insert 8 (user-supplied) D-cell batteries to power motor drives and Autostar handbox.

28 Want to learn more about setting the latitude dials?

LXD75 TIPS

Join an Astronomy Club, Attend a Star Party

One of the best ways to increase your knowledge of astronomy is to join an astronomy club. Check your local newspaper, school, library, or telescope dealer/store to find out if there's a club in your area.

At club meetings, you will meet other astronomy and Meade enthusiasts with whom you will be able to share your discoveries. Clubs are an excellent way to learn more about observing the sky, to find out where the best observing sites are, and to compare notes about telescopes, eyepieces, filters, tripods, and so forth.

Often, club members are excellent astrophotographers. Not only will you be able to see examples of their art, but you may even be able to pick up some "tricks of the trade" to try out on your LX D75-Series telescope. See page 36 for more information about photography with the LX D75-Series.

Many groups also hold regularly scheduled Star Parties at which you can check out and observe with many different telescopes and other pieces of astronomical equipment. Magazines such as *Sky & Telescope* and *Astronomy* print schedules for many popular Star Parties around the United States and Canada.

AUTOSTAR FEATURES

Important Note: The model SN-6EC, model SN-8EC, and model AR-5EC are equipped with an Electronic Controller handbox, rather than the Autostar Handbox. Several of the following procedures, such as Tracking Objects and Initializing Autostar (to name but a few), are relevant only to models equipped with the Autostar handbox and do not apply to the EC models. For more information about the EC handbox, see APPENDIX D: EC HANDBOX, page 58.

Note: Autostar does not require batteries; the telescope's batteries supply power to Autostar.

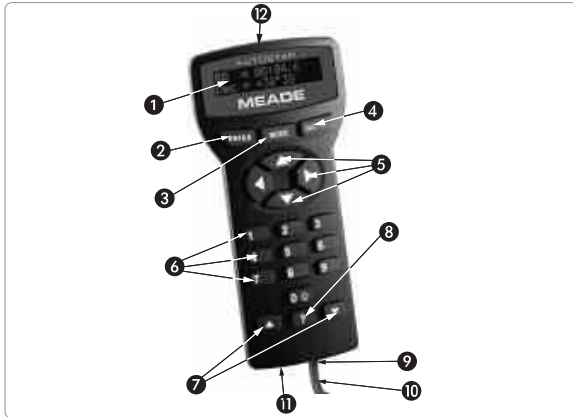

Fig. 2: The Autostar Handbox.

Tour the Cosmos with Just the Push of a Button

Control of most LXD75-Series telescope models (excluding the EC models; see margin note) is through the operation of Autostar. Nearly all functions of the telescope are accomplished with just a few pushes of Autostar's buttons. Some of the major features of Autostar are:

- Automatic GO TO capability: Automatically move the telescope to any of the more than 30,000 objects stored in the object library.
- Take a guided tour of the best celestial objects to view on any given night of the year.
- Download the latest satellite data and software revisions directly from the Meade website (www.meade.com) and share software with other Autostar enthusiasts.
- Access a glossary of astronomical terms.
- Fully automatic tracking of celestial objects.

Features

The Autostar Computer Controller provides control of virtually every telescope function within a compact handbox. Autostar has soft-touch keys designed to have a positive feel. The LCD (Liquid Crystal Display) is backlit with a red LED (Light Emitting Diode) for easy viewing in the dark. The backlit display, key arrangement, and sequential menu structure make Autostar extremely user friendly.

- 1 **2-Line LCD Display:** This screen displays Autostar's menus and other information about the telescope.
- **Top line:** Lists the primary menu.
- **Bottom line:** Contains other menus that may be selected, menu options, telescope status, or information about a function that is currently being performed.
- 2 **ENTER Key:** Press to go to the next menu level or to choose an option in a menu. The ENTER key is similar to the RETURN or ENTER key on a computer. See MOVING THROUGH AUTOSTAR'S MENUS, page 19 and AUTOSTAR'S MENUS, page 25.

Tip:
If the "ENTER to Sync" feature is accessed by mistake, press MODE to return to the previous screen.

4 Want to learn more about using the GO TO function? See page 21.

Want to learn how to perform a spiral search? See page 21.

Definitions:
"Slew" means to move the telescope's optical tube to a selected object.



Fig. 3: Spread out the tripod legs. (See next page.)

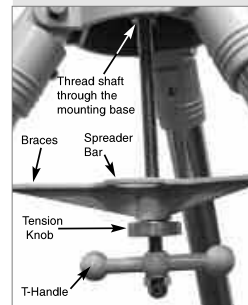

Fig. 4: Thread T-handle shaft into base. (See next page.)

Note: If ENTER is pressed for two seconds or more and then released, Autostar emits a beep and "ENTER to Sync" is displayed. "ENTER to Sync" may be used only after your telescope has been aligned and is pointing at an object. See page 30 for more details.

- 3 **MODE Key:** Press to return to the previous menu level. The top menu level is "Select Item." The MODE key is similar to the ESCAPE key on a computer.

Note: Pressing MODE repeatedly while in the "Select Item" level moves Autostar to the topmost screen: "Select Item: Object."

Note: If MODE is pressed and held for two seconds or more, information about the telescope's status displays. When the status displays, press the Scroll keys (7, Fig. 2) to display the following information and more:

- Right Ascension and Declination (astronomical) coordinates
- Altitude (vertical) and Azimuth (horizontal) coordinates
- Local Time and Local Sidereal Time (LST)
- Timer and Alarm Status

Press MODE again to return to the previous menu.

- 4 **GO TO Key:** Press to slew (move) the telescope to the coordinates of the currently selected object. While the telescope is slewing, the operation may be aborted at any time by pressing any key except GO TO. Pressing GO TO again resumes the slew to the object. Also, press GO TO after a slew is completed to activate a "spiral search."
- 5 **Arrow Keys:** Press to slew the telescope in a specific direction (up, down, left, and right), at any one of nine different speeds. See SLEW SPEEDS, page 16.
- 6 **Number Keys:** Press to input digits 0 to 9. When data is not being entered, the Number keys can be used to change the slew speed. To operate, just press a number key (1 is the slowest speed, 9 is the highest speed). Press the Number key "0" to turn on and off the red utility light on the top of the handbox.
- 7 **Scroll Keys:** Press to access options within a selected menu. The menu is displayed on the first line of the screen. Options in that menu are displayed, one at a time, on the second line. Press the Scroll keys to move through the options. Press and hold a Scroll key to move quickly through the options.
- 8 **? Key:** Press to access the "Help" function. Help provides on-screen information on how to accomplish whatever task is currently active. Hold down the ? key and then follow the prompts on the display to access details of Autostar functions in the Help feature. The Help system is essentially an on-screen instruction manual. If you have a question about an Autostar operation, e.g., INITIALIZATION, ALIGNMENT, etc., hold down the ? key and follow the directions that scroll on the second line. When satisfied with the Help provided, press MODE to return to the original screen and continue with the chosen procedure.
- 9 **Coil Cord Port:** Plug one end of the Autostar coil cord (see 10) into this port located at the bottom of the Autostar handbox and the other end into the HBX port of the computer control panel (A, Fig. 1e).
- 10 **Coil Cord:** Plug one end of the Autostar coil cord into the HBX port (A, Fig. 1e) of the computer control panel of the telescope and the other end into the Autostar coil cord port (See 9).
- 11 **RS232 Port:** Plug in RS232 connections for downloading and connecting to computer. Useful for downloading the latest satellite data and software revisions directly from the Meade website (www.meade.com). Requires optional #505 AstroFinder™ Software and Cable Connector Kit. See OPTIONAL ACCESSORIES, page 38.
- 12 **Utility Light:** Use this built-in red light to illuminate star charts and accessories without disturbing your eye's adaptation to darkness. Press "0" to turn the light on and off.

GETTING STARTED

As you unpack your telescope, carefully note the following parts. The assembly is shipped in separate boxes.

Telescope Assembly

- Equatorial mount with polar alignment finder
- Heavy duty, adjustable aluminum tripod with leg braces, three tripod leg lock knobs, and a captive mount locking knob
- Complete optical tube assembly including primary mirror with dust cover and a rack-and-pinion focuser and eyepiece holders for both 1.25" and 2" eyepiece holders, tube cradle assembly with two rings and two lock knobs
- Super Plössl (SP) 26mm eyepiece
- Counterweight and counterweight shaft. The 8" and 10" models include extra counterweights.
- 8 x 50mm (all models, except N-6EC Newtonian) or 6 x 30mm (N-6EC Newtonian only) viewfinder.
- Factory-mounted dual electronic motor drive assembly
- Autostar handbox, detachable coil cord, or Electronic Controller
- Battery pack and holder

Accessories

- Hex keys, T-Adapter (included with Schmidt-Newtonian models only)

How to Assemble Your Telescope

The giftboxes contain the optical tube assembly and the tripod with the equatorial mount. The accessories are located within compartments custom-cut into the styro-foam block inserts.

1. **Remove the components from the giftboxes:** Remove and identify the telescope's equipment. Refer to **Figures 1a through 1f** for images of the parts and the overall assembly of your telescope. When removing the tripod from the gift-box, hold the assembly parallel (horizontal) to the ground or the inner tripod leg extensions will slide out as they are not locked in place.
2. **Adjust the tripod legs.** Spread the tripod legs as far as they will open. See **Fig. 3**.
3. **Attach the spreader bar to the tripod with shaft:** Thread the tension knob onto the shaft (see **Fig. 4**). Place the spreader bar over the T-handle shaft. Slide the bushing, the wide open side facing downward, onto the shaft as far as it will go (**Fig. 5a**). Then slide the shaft up through the tripod mounting base (**37, Fig. 1c**). Above the mount, snap the e-clip into the second, narrower pre-cut slot (see **Fig. 5a**) of the shaft (**Fig. 5b**).
4. **Attach mount to tripod base:** Place the mount over the tripod mounting base (**37, Fig. 1c**) and onto the shaft, with the protrusion on top of the tripod's base positioned between the fine azimuth control knobs (**27, Fig. 1d**). See **Fig. 5c**. If necessary, back off the azimuth control knobs wide enough for protrusion to fit between them.

Tighten the T-handle to a firm feel. This attachment keeps the tripod and the telescope mount securely in place. Then line up the spreader bar braces so that they are each touching one of the tripod legs. Tighten the tension knob (**39, Fig. 1c**) to a firm feel. When you wish to collapse the tripod, loosen the tension knob and move the braces off the legs. You do not need to remove the T-handle/shaft.

5. **Attach the counterweight(s) to the counterweight shaft:** Place the counterweight shaft base (**20, Fig. 1d**) over the threaded end of the shaft (**22, Fig. 1d**). Thread the shaft and base assembly into the hole beneath the Dec. setting circle as depicted in **Fig. 6**.

Look through the hole in the counterweight and note the pin blocking the hole. Tilt the counterweight slightly and the pin moves out of position, clearing the hole. If the pin does not move, unscrew the counterweight lock knob slightly until the pin moves. Unscrew the safety cap (**23, Fig. 1d**) from the shaft. Holding the counterweight (**21, Fig. 1d**) firmly in one hand, slip the counterweight to approximately the mid-point of the counterweight shaft (**22, Fig. 1d**). Tighten the counterweight lock knob to a firm feel. Replace the safety cap.

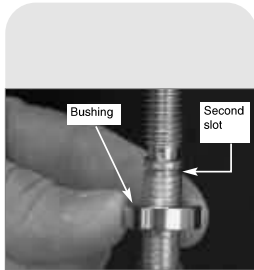

Fig. 5a: Slide bushing over shaft.



Fig. 5b: Snap e-clip all the way onto shaft above mount (shown partially attached).

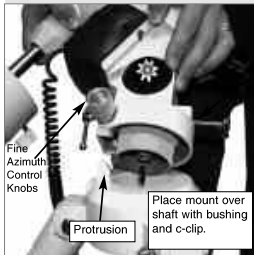

Fig. 5c: Attach the mount to the tripod.

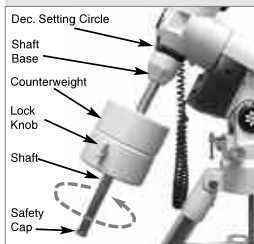

Fig. 6: Attach counterweight assembly.

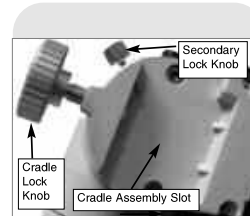

Fig. 7: Attach cradle to base mounting slot and tighten locking knobs.

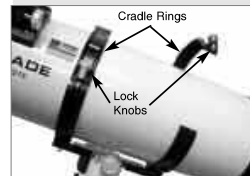

Fig. 8: Place optical tube in rings and loosely tighten cradle ring lock knobs.

Note: Model SC-8 users: After completing step 6, refer to **APPENDIX E, page 62, step 1**, for information on how to attach the SC optical tube to the mount.

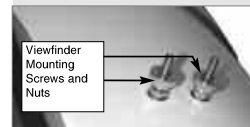

Fig. 9a: Viewfinder assembly, Newtonian reflector models.



Fig. 9b: Viewfinder assembly, refractor and Schmidt-Newtonian and Schmidt-Cassegrain models.

Note: If the counterweight ever slips, the safety cap (**23, Fig. 1d**) prevents the counterweight from sliding entirely off the shaft. Always leave the safety cap in place when the counterweight is on the shaft.

6. **Set the latitude:** Setting the latitude is easier if it is set before you attach the optical tube to the assembly. Locate the latitude dial (**28, Fig. 1d**); note that there is a triangular pointer above the dial located on the mount. The pointer is not fixed; it moves as the mount moves.

Determine the latitude of your observing location. See **APPENDIX C: LATITUDE CHART**, page 57, for a list of latitudes, or check an atlas. Move the latitude T-handle screws in order to move the mount until the pointer points to your latitude. The two T-handle screws work in a "push - pull" operation—as you tighten one, loosen the other. When the pointer points at your latitude, tighten both screws until they make contact with the mount.

At your observing site, set up the telescope assembly so that the tripod leg below the Fine Azimuth Control Knobs (**27, Fig. 1c**) approximately faces North (or South in the Southern Hemisphere). Model SC-8 users, see **APPENDIX E, page 62**.

7. **Attach the cradle assembly to the mount:** Remove the optical tube from the cradle and slide the cradle assembly (**11, Fig. 1a**) onto the cradle mounting slot. See **Fig. 7**. The rounded base of the cradle assembly fits into the rounded portion of the mounting slot. Tighten both the cradle locking knob and the secondary locking knob to a firm feel.
8. **Position optical tube:** Unscrew the cradle ring lock knobs (**13, Fig. 1a**) and open the cradle rings. While firmly holding the optical tube (**10, Fig. 1a**), position it onto the cradle rings (**14, Fig. 1a**) with the mid-point of the optical tube's length lying roughly in the center of the cradle ring assembly. Point the tube so that the front end (this end comes shipped with the dust cover (**9, Fig. 1a**) over it) is oriented as depicted in **Fig. 1a**. Then close the cradle rings (**14, Fig. 1a**) over the optical tube. Loosely tighten the cradle ring lock knobs just to hold the tube securely in place until you balance it. See **BALANCING THE TELESCOPE**, page 13.
9. **Attach viewfinder bracket: Newtonian models (Fig. 9a):** Locate the viewfinder bracket screws (**Fig. 9a**) and remove the nuts from the screws. Slide the holes in the viewfinder bracket over the viewfinder bracket screws. Replace the nuts and tighten to a firm feel only.

Attach viewfinder tube: Back off the viewfinder collimation screws (**5, Fig. 1b**) and slide the viewfinder tube into the bracket. Orient the viewfinder eyepiece as depicted in **Fig. 1b**. Tighten the collimation screws to a firm feel. See **ALIGNING THE VIEWFINDER**, page 14.

Attach viewfinder bracket: Achromatic refractor, Schmidt-Newtonian and Schmidt-Cassegrain models (15, Fig. 1b and Fig. 9b): Slide the track on the bottom of the viewfinder bracket into the slot in the viewfinder mounting assembly (which is already attached to the tube). To secure the viewfinder to the mounting assembly, tighten the two thumbscrews to a firm feel only.

Attach viewfinder tube: Back off the viewfinder collimation screws (**5, Fig. 1b**) and slide the viewfinder tube into the bracket. Point the viewfinder eyepiece toward the focuser assembly. See **Fig. 10b**. Tighten the collimation screws to a firm feel. See **ALIGNING THE VIEWFINDER**, page 14.

10. **Insert the eyepiece: Schmidt-Newtonian and Newtonian models (Fig. 10a):** Lift to remove the dust cap from the eyepiece holder on the focuser assembly. Set the dust cap aside in a safe place and replace it when you have finished observing to protect the eyepiece assembly. Back off the eyepiece thumbscrews (**1, Fig. 1a**) and insert the supplied SP 26mm eyepiece (**3, Fig. 1a**) into the eyepiece holder. Tighten the holder thumbscrews to a firm feel to secure the eyepiece.

Insert the eyepiece: Achromatic refractor and Schmidt-Cassegrain models (Fig. 10b): Lift to remove the dust cap from the eyepiece holder on the focuser assembly. Set the dust cap aside in a safe place and replace it when you have finished observing to protect the eyepiece assembly. Back off the eyepiece thumbscrews (**1, Fig. 1b**) and slide the diagonal into the holder and tighten the thumbscrews to a firm feel only. Insert the supplied SP 26mm eyepiece (**3, Fig.**

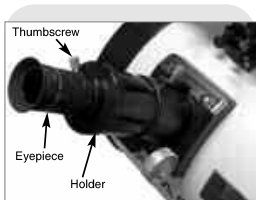

Fig. 10a: Insert eyepiece into holder and tighten thumbscrews.

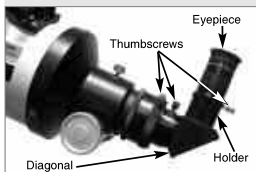

Fig. 10b: Insert eyepiece into diagonal and tighten thumbscrews.

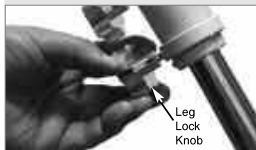

Fig. 11: Adjust the tripod height using the leg lock knobs.



Fig. 12: Battery holder.



Fig. 13: Reticle assembly.

1b) into the the diagonal. Tighten the diagonal's thumbscrews to a firm feel to secure the eyepiece.

Note: Two eyepiece holders are included with your telescope—for both 1.25" and 2" eyepieces. To change eyepiece holders, unscrew the attached holder from the focuser and thread on the other holder.

11. **Adjust the height of the tripod:** Adjust the height of the tripod by loosening the tripod lock knobs (Fig. 11). Extend the sliding inner section of each tripod leg to the desired length; then tighten each knob. Adjust the tripod to a height that is comfortable for viewing.
12. **Install Batteries:** Insert eight (user-supplied) D-size batteries into the battery holder, oriented as shown in the diagram on the battery slots of the holder. Plug the battery pack into the 12v DC connector (B, Fig. 1e) on the computer control panel. See Fig. 12.

Caution: Use care to install batteries as indicated by the battery compartment. Follow battery manufacturer's precautions. Do not install batteries backwards or mix new and used batteries. Do not mix battery types. If these precautions are not followed, batteries may explode, catch fire, or leak. Improperly installed batteries void your Meade warranty. Always remove the batteries if they are not to be used for a long period of time.

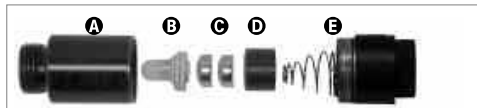

Fig. 13b: Reticle LED assembly: (A) Reticle Container; (B) LED; (C) Batteries; (D) Battery Holder; (E) Cap.

13. **Remove Plastic Strip from Reticle LED:** The polar alignment reticle LED (30, Fig. 1d) contains two watch batteries. The reticle's LED is shipped with a plastic strip between the two batteries to protect battery life. Unthread both the cap (E). Remove the plastic strip before using. Refer to the reticle assembly in Fig. 13b and note the orientation of the batteries. Place the batteries (C) into the battery holder (D) before inserting into the reticle container (A).

Note: Remember to turn off the LED when you are not using the reticle.

14. **Plug in Autostar or EC Handbox:** Plug the Autostar or EC handbox cable into the HBX port (A, Fig. 1e).

Balancing the Telescope

In order for the telescope to be stable on the tripod and also for it to move smoothly, it must be balanced. To balance the telescope, unlock the Right Ascension or R.A. lock (33, Fig. 1d). When this axis is unlocked, the telescope pivots on the R.A. axis. Later in the procedure, you will also unlock the Declination or Dec. lock (17, Fig. 1d). When unlocked, the telescope pivots on the Dec. axis. Most of the motion of the telescope takes place by moving about these two axes, separately or simultaneously. Try to become familiar with these locks and observe how the telescope moves on each axis. To obtain a fine balance of the telescope, follow the method below:

1. Firmly hold the optical tube secure so that it cannot accidentally swing freely. Loosen the R.A. lock (33, Fig. 1d). The optical tube now moves freely about the R.A. axis. Rotate the telescope so that the counterweight shaft (22, Fig. 1d) is parallel (horizontal) to the ground.
2. Unlock the counterweight lock knob and slide the counterweight (21, Fig. 1d) along the counterweight shaft until the telescope remains in one position without tending to drift down in either direction. Then re-tighten the counterweight lock knob, locking the counterweight in position.

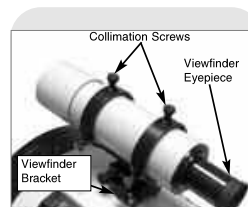

Fig. 14a: Viewfinder assembly, refractor and Schmidt-Newtonian mod-

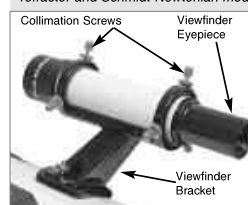

Fig. 14b: Viewfinder assembly, Newtonian models.

Important Note: Objects appear upside-down and reversed left-for-right when observed in the viewfinder. With refracting telescope models, objects viewed through the main telescope with the diagonal mirror in place are seen right-side-up, but reversed left-for-right.

This image inversion is of no consequence when observing astronomical objects, and in fact all astronomical telescopes yield inverted images.

During terrestrial observing, where a fully-correctly-oriented image (right-side up and correct left-for-right) is desirable, an optional Meade #928 45° Erect-Image Diagonal Prism is available. See **OPTIONAL ACCESSORIES**, page 38.

Note that for Schmidt-Newtonian models, no means of image inversion is available; while these telescopes may be used for terrestrial observing, the image will not be correctly oriented in either right-side-up or left-for-right orientations.

3. **Achromatic refractor, Schmidt-Newtonian models and Newtonian models:** Again, hold the optical tube so that it cannot accidentally swing freely. Lock the R.A. lock (33, Fig. 1d), and unlock the Dec. lock (17, Fig. 1d). The telescope now is able to move freely about the Dec. axis. Loosen the cradle ring lock knobs (13, Fig. 1a) so that the main tube slides easily back and forth in the cradle rings. Move the main tube in the cradle rings until the telescope remains in one position without tending to drift down in either direction. Re-lock the Dec. lock (17, Fig. 1d).

The telescope is now properly balanced on both axes. Next, the viewfinder must be aligned.

Aligning the Viewfinder

The wide field of view of the telescope's viewfinder (4, Fig. 1a) provides an easier way to initially sight objects than the main telescope's eyepiece (3, Fig. 1a), which has a much narrower field of view. If you have not already attached the viewfinder to the telescope tube assembly, follow the procedure described in step 9, page 12.

In order for the viewfinder to be useful, it must be aligned to the main telescope, so that both the viewfinder and telescope's optical tube (10, Fig. 1a) point at the same position in the sky. This alignment makes it easier to find objects: First locate an object in the wide-field viewfinder, then look into the eyepiece of the main telescope for a detailed view.

To align the viewfinder, perform steps 1 through 4 during the daytime; perform step 5 at night. Both the 6 x 30mm and the 8 x 50mm viewfinders align in an identical manner. Refer to Figs. 14a and 14b.

1. Remove the dust covers from the optical tube (9, Fig. 1a) and the viewfinder.
2. If you have not already done so, insert the low-power SP 26mm eyepiece (3, Fig. 1b) into the eyepiece holder of the main telescope. See step 10, page 12.
3. Look through the viewfinder eyepiece at an object at least one-half mile away (**Tip: Remove the viewfinder tube from the bracket to simplify this operation.** If the distant object is not in focus, turn the focus lock ring counterclockwise to loosen the viewfinder front cell (6, Fig. 1b). Twist the front cell until focus is achieved and retighten the focus lock ring.
4. Unlock the R.A. lock (33, Fig. 1d) and the Dec lock (17, Fig. 1d) so that the telescope turns freely on both axes. Then point the main telescope at a tall, well-defined and stationary land object (e.g., the top of a telephone pole) at least 200 yards distant and center the object in the telescope's eyepiece. Focus the image by turning the focus knobs (8, Fig. 1b). Retighten the R.A. and Dec. locks.
5. Look through the viewfinder and loosen or tighten, as appropriate, one or more of the viewfinder collimation thumbscrews (5, Fig. 1b) until the viewfinder's crosshairs are precisely centered on the object you previously centered in the main telescope's eyepiece. You are now ready to make your first observations with your telescope.

NEVER point the telescope directly at or near the Sun at any time! Observing the Sun, even for the smallest fraction of a second, will result in instant and irreversible eye damage, as well as physical damage to the telescope itself.

5. Check this alignment on a celestial object, such as a bright star or the Moon, and make any necessary refinements, using the method outlined above in steps 3 and 4.

With this alignment performed, objects first located in the wide-field viewfinder will also appear in the telescope's eyepiece.

Choosing an Eyepiece

A telescope's eyepiece magnifies the image formed by the telescope's main optics. Each eyepiece has a focal length, expressed in millimeters, or "mm." The smaller the focal length, the higher the magnification. For example, an eyepiece with a focal length of 9mm has a higher magnification than an eyepiece with a focal length of 26mm.

Your telescope comes supplied with a Super Plössl (SP) 26mm eyepiece which gives a wide, comfortable field of view with high image resolution.

Note: Seeing conditions vary widely from night-to-night and site-to-site. Turbulence in the air, even on an apparently clear night, can distort images. If an image appears fuzzy and ill-defined, back off to a lower power eyepiece for a more well-resolved image (see Fig. 15a and 15b below).

Note: For a list of magnification ratings of the eyepieces available for the LXD75-Series telescopes, see **OPTIONAL ACCESSORIES**, page 37.

Low power eyepieces offer a wide field of view, bright, high-contrast images, and eye relief during long observing sessions. To find an object with a telescope, always start with a lower power eyepiece such as the Super Plössl 26mm. When the object is located and centered in the eyepiece, you may wish to switch to a higher power eyepiece to enlarge the image as much as practical for prevailing seeing conditions. For information about optional eyepieces for the LXD75-Series models, see **OPTIONAL ACCESSORIES**, page 37.

The power, or magnification of a telescope is determined by the focal length of the telescope and the focal length of the eyepiece being used. To calculate eyepiece power, divide the telescope's focal length by the eyepiece's focal length. For example, a 26mm eyepiece is supplied with the LXD75-Series. The focal length of the 8" LXD75-Series model is 812mm (see **SPECIFICATIONS**, page 46).

$$\begin{aligned} \text{Telescope Focal Length} \div \text{Eyepiece Focal Length} &= \text{Magnification (Power)} \\ \text{Telescope Focal Length} &= 812\text{mm} \\ \text{Eyepiece Focal Length} &= 26\text{mm} \\ 812 \div 26 &= 31 \end{aligned}$$

The eyepiece power, or magnification is therefore 31X (approximately).

Observing by Moving the Telescope Manually

After the telescope is assembled and balanced as described previously, you are ready to begin manual observations. View easy-to-find terrestrial objects such as street signs or traffic lights to become accustomed to the functions and operations of the telescope. For the best results during observations, follow the suggestions below:

- When you wish to locate an object to observe, first loosen the telescope's R.A. lock (33, Fig. 1d) and Dec. lock (17, Fig. 1d). The telescope can now turn freely on its axes. Unlock each axis separately and practice moving your telescope. Then practice with two unlocked axes at the same time. **It is very important to practice this step** to understand how your telescope moves, as the movement of an equatorial mount is not intuitive.
- Use the aligned viewfinder to sight-in on the object you wish to observe. When the object is centered in the viewfinder's crosshairs, re-tighten the R.A. and Dec. locks.
- A telescope's eyepiece magnifies the image formed by the telescope's main optics. Each eyepiece has a focal length, expressed in millimeters, or "mm." The smaller the focal length, the higher the magnification. For example, an eyepiece with a focal length of 9mm has a higher magnification than an eyepiece with a focal length of 26mm.

Low-power magnification eyepieces offer a wide field of view, bright, high-contrast images, and relief of eye strain during long observing sessions. To observe an object with a telescope, always start with a low power eyepiece such as the SP 26mm

LXD75 TIPS

Too Much Power?

Can you ever have too much power? If the type of power you're referring to is eyepiece magnification, yes, you can! The most common mistake of the beginning observer is to "overpower" a telescope by using high magnifications which the telescope's aperture and atmospheric conditions cannot reasonably support. Keep in mind that a smaller, but bright and well-resolved image is far superior to one that is larger, but dim and poorly resolved (see Figs. 15a and 15b). Powers above 400X should be employed only under the steadiest atmospheric conditions.

Autostar can calculate the best eyepiece for you to use. Try out the "Eyepiece Calc" feature in the Utilities menu.

Most observers should have three or four additional eyepieces to achieve the full range of reasonable magnifications possible with the LXD75-Series telescopes. See **OPTIONAL ACCESSORIES**, page 37.

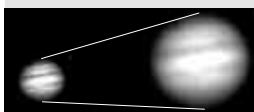

Fig. 15a & 15b: Jupiter; examples of the right amount of magnification and too much magnification.

Note: Autostar only prompts you to enter Country (or State) and City as described in steps 3, 4, and 5, the first time it is activated. These prompts do not appear again, unless you reset Autostar (see **RESET**, page 31).

However, if you need to re-enter this information (e.g., you change your geographic location), you can change the location information by using the Site option of the Setup menu. See **ADDING OBSERVING SITES**, page 32, for detailed information.

supplied with your telescope. When the object is centered and focused in the eyepiece, switch to a higher power eyepiece to enlarge the image as much as practical for prevailing viewing conditions. For information about other eyepieces available for your telescope, see **OPTIONAL ACCESSORIES**, page 37.

- Once centered, an object can be focused by turning one of the knobs of the focusing mechanism (8, Fig. 1b). Notice that when observing astronomical objects, the field of view begins to slowly drift across the eyepiece field. This motion is caused by the rotation of the Earth on its axis. Objects appear to move through the field more rapidly at higher powers. See **TRACKING OBJECTS**, page 17, for detailed information on how you can counteract the drift in the field of view.

Activate the Arrow Keys (Autostar Models Only)

Autostar's Arrow keys allow you to slew (move) the telescope up, down, right, or left. The following procedure describes how to activate Autostar's Arrow keys:

1. After the batteries are installed and Autostar's cord is plugged into the HBX port of computer control panel (A, Fig. 1e), a copyright message lights on the Autostar LCD display (1, Fig. 2).
2. A message warning not to look at the Sun scrolls across the display. Press the key prompted by Autostar to acknowledge that the Sun warning has been read and understood.
3. Press **ENTER** (2, Fig. 2) repeatedly until "Country/State" appears on the display. (Ignore the prompts requesting Date and Time. See **INITIALIZING AUTOSTAR**, page 19, for more information).
4. Use the Scroll keys (7, Fig. 2) to cycle through the database of countries, states, and provinces. Press **ENTER** when the correct location displays.
5. Autostar then prompts you to enter the nearest city (listed alphabetically) to the observing site. Use the Scroll keys to cycle through the database of cities. Press **ENTER** when the correct city appears on the display.
6. Autostar then prompts you to enter the model number of your telescope. Use the Scroll keys to cycle through the list of telescope models. Press **ENTER** when the correct model appears on the display.
7. The display then reads "Align: Easy." You now can use Autostar's Arrow keys to move the telescope to observe.

Note: If you go past the "Align: Easy" (or any other menu display you wish to select), press **MODE** to return to the previous display(s).

8. Press the Arrow keys (5, Fig. 2) to move the telescope up, down, right, or left. You can move the telescope at different speeds.

Slew Speeds (Autostar Models Only)

Autostar has nine slew speeds that move the optical tube at rates that are directly proportional to the sidereal rate and have been calculated to accomplish specific functions. Press a Number key (6, Fig. 2) to change the slew speed, which is shown for about two seconds on Autostar's display.

The nine available speeds are:

Number Key 1 =	Guide (0.25 arc-min/sec or 0.004°/sec)
Number Key 2 = 2x =	2 x sidereal (0.5 arc-min/sec or 0.008°/sec)
Number Key 3 = 8x =	8 x sidereal (2 arc-min/sec or 0.033°/sec)
Number Key 4 = 16x =	16 x sidereal (4 arc-min/sec or 0.067°/sec)
Number Key 5 = 64x =	64 x sidereal (16 arc-min/sec or 0.27°/sec)
Number Key 6 = 128x =	30 arc-min/sec or 0.5°/sec
Number Key 7 = 1.5° =	90 arc-min/sec or 1.5°/sec
Number Key 8 = 3° =	180 arc-min/sec or 3°/sec
Number Key 9 = Max =	270 arc-min/sec or 4.5°/sec

Note: If you wish to perform a more precise polar alignment for the purposes of astrophotography, see "Appendix B," page 52.

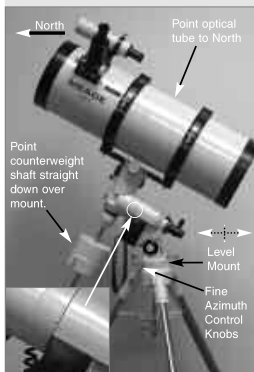

Fig. 16a: The polar home position, side view. *Inset:* Line up triangles on the mount.



Fig. 16b: The polar home position, front view.

Speeds 1, 2, or 3: Best used for fine centering of an object in the field of view of a higher power eyepiece, such as a 12mm or a 9mm eyepiece.

Speeds 4, 5, or 6: Enables centering an object in the field of a low-to-moderate power eyepiece, such as the standard Super Plössl 26mm.

Speeds 7 or 8: Best used for rough centering of an object in the viewfinder.

Speed 9: Moves the telescope quickly from one point in the sky to another.

Observe the Moon

Point your telescope at the Moon (note that the Moon is not visible every night). Use your EC handbook or Autostar to practice using the Arrow keys and the slew speeds to view different features. The Moon contains many interesting features, including craters, mountain ranges, and fault lines. The best time to view the Moon is during its crescent or half phase. Sunlight strikes the Moon at an angle during these periods and adds a depth to the view. No shadows are seen during a full Moon, making the overly bright surface to appear flat and rather uninteresting. Consider the use of a neutral density Moon filter when observing the Moon. See **OPTIONAL ACCESSORIES**, page 38. Not only does it cut down the Moon's bright glare, but it also enhances contrast, providing a more dramatic image.

Tracking Objects

As the Earth rotates beneath the night sky, the stars appear to move from East to West. The speed at which the stars move is called the sidereal rate. You can setup your telescope to move at the sidereal rate so that it automatically tracks the stars and other objects in the night sky. The tracking function automatically keeps an object more or less centered in the telescope's eyepiece.

To automatically track objects, you first need to learn how to set the polar home position of your telescope and then how to select "Targets: Astronomical" from the Autostar Setup menu. EC handbook users, see **APPENDIX D**, page 58, for more information.

Setting the Polar Home Position

1. Level the mount, if necessary, by adjusting the length of the three tripod legs.
2. Unlock the R.A. Lock (33, Fig. 1d). Rotate the Optical Tube Assembly until the counterweight shaft is pointing straight down over the mount. See **Figs. 16a** and **16b**.
3. If you have not already done so, lift the telescope assembly and turn it so the tripod leg below the Fine Azimuth Control Knobs (27, Fig. 1c) approximately faces North (or South in the Southern Hemisphere). Release the Dec. lock (17, Fig. 1d) of the tripod, so that the optical tube (10, Fig. 1a) may be rotated. Rotate the optical tube until it points North (or South in the Southern Hemisphere). Then re-tighten the lock. Locate Polaris, the North Star, if necessary, to use as an accurate reference for due North (or Sigma Octantis in the Southern Hemisphere). See **LOCATING THE CELESTIAL POLE**, page 51.
4. If you have not already done so, determine the latitude of your observing location. See **APPENDIX C: LATITUDE CHART**, page 57, for a list of latitudes of major cities around the world. Use the latitude T-handle screws (26, Fig. 1d) to tilt the telescope mount so that the pointer indicates the correct latitude of your viewing location on the latitude dial (28, Fig. 1d). See step 6, page 12 for more information.
5. If steps 1 through 4 above were performed with reasonable accuracy, your telescope is now sufficiently well-aligned to Polaris, the North Star, for you to begin making observations.

Once the mount has been placed in the polar home position as described above, the latitude angle need not be adjusted again, unless you move to a different geographical location (*i.e.*, a different latitude).

Important Note: For almost all astronomical observing requirements, approximate settings of the telescope's latitude and other settings are acceptable. Do not allow undue attention to precise settings of polar home position of the telescope to interfere with your basic enjoyment of the instrument.

Tip:

You can change the telescope's slew rate while centering an object in the eyepiece. See **SLEW SPEEDS**, page 16 for more information.

Important Note: While performing the automatic tracking procedure, you may use the Arrow keys to move the telescope or you may also loosen the telescope locks (17 and 33, Fig. 1d) and move the optical tube manually to locate another object in the sky. The tracking function will continue to be operational and the telescope will track the new object.

Observe a Star using the Automatic Tracking Feature

In this example, Autostar's Arrow keys are used to find a star, and then Autostar's tracking capability automatically keeps the star centered in your telescope's eyepiece. EC handbook users, see **APPENDIX D**, page 58, for information about tracking with the EC handbook.

1. If you have activated the Arrow keys and completed setting the telescope in the polar home position, Autostar's display now reads "Align: Easy." Go to Step 2. If you have not used Autostar yet or have just plugged it into the HBX port, perform the procedures described in **ACTIVATE THE ARROW KEYS**, page 16 and **SETTING THE POLAR HOME POSITION**, page 17. Then go to Step 2 of this procedure. If you have been using Autostar to perform other functions and the display does not read "Align: Easy," follow these steps:
 - a. Press MODE (3, Fig. 2) repeatedly until "Select Item: Object" displays.
 - b. Press the Scroll Up key (7, Fig. 2) once. "Select Item: Setup" displays.
 - c. Press ENTER (2, Fig. 2). "Setup: Align" displays. Go to Step 3.
2. Press MODE (3, Fig. 2). "Setup: Align" displays.
3. Press the Scroll Down key repeatedly until "Setup: Targets" displays. Press ENTER (2, Fig. 2).
4. "Targets: Terrestrial" displays. Press one of the Scroll keys once (7, Fig. 2). "Targets: Astronomical" now displays.
5. Use the Arrow keys (5, Fig. 2) to locate a bright star in the night sky. Use the viewfinder to help line up on the star. You may choose any unobstructed, bright star for the purposes of this example. Use Autostar's Arrow keys to center the star in the eyepiece. Once the star is centered, press ENTER to select "Astronomical." The telescope's tracking motors then engage. It may take the tracking motors several seconds to begin tracking. When they do, it may be necessary to once again center the star in the eyepiece. The tracking motors will then keep any star you choose in the center of the eyepiece.
6. Press and hold the ENTER key for a few seconds and then release to stop tracking. You may also stop tracking by choosing "Terrestrial" in the Targets menu.

Using Autostar's GO TO Capabilities (Autostar Models Only)

Before you can use Autostar's GO TO capabilities, you must first:

- Learn how Autostar's keys move through the menus
- Initialize Autostar
- Place the telescope in the polar home position, if you have not already done so (see **SETTING THE POLAR HOME POSITION**, page 17)
- Select "Align: Easy" from Autostar's menus

LXD75 TIPS

Which One's the Alignment Star?

If Autostar has chosen an alignment star with which you are unfamiliar, how can you be sure if the star in your eyepiece is really the alignment star?

The rule of thumb is that an alignment star is usually the brightest star in that area of the sky. If you perform a GO TO to an alignment star and you're not sure if you have located the alignment star or it isn't in the eyepiece, look through your viewfinder. When you view an alignment star in the viewfinder, it stands out dramatically from the rest of the stars in that portion of the sky. The viewfinder will help you locate a star more quickly than the eyepiece, because it has a much wider field of view than the eyepiece. Using Autostar, set the slew speed to 6 or higher and use the Arrow keys to center the alignment star in the viewfinder. If your viewfinder has been aligned with the telescope, the alignment star should now be in the eyepiece. Set the slew speed to 4 or less and center the star in the eyepiece. Also see the "Spiral Search" tip on page 21.

If you have an obstruction, such as a tree or a building blocking your view of the alignment star, or if you have any doubts at all about the star that has been chosen, no problem. Just press the Scroll Down key and Autostar will find another star to align upon.

Tip:

When multiple choices are available within a menu option, the current option is usually displayed first and highlighted by a right pointing arrow (>).

Definition:

Initialization is a procedure that ensures that Autostar operates correctly. When you first use Autostar, it doesn't yet know where the observation location site is or the time or date of the observation session.

You will enter information, such as the current time and date, and observation location.

Autostar uses this information to precisely calculate the location of celestial objects (such as stars and planets) and to automatically move your telescope correctly for various operations.

Moving Through Autostar's Menu (Autostar Models Only)

Autostar's menus are organized for quick and easy navigation.

- Press ENTER (2, Fig. 2) to go deeper into Autostar menu levels.
- Press MODE (3, Fig. 2) to move back toward the top menu level.
- Press the Scroll keys (7, Fig. 2) to move up and down through the options available for each menu level.
- Press the Arrow keys (5, Fig. 2) to enter characters.
- Press the Number keys (6, Fig. 2) to enter digits.

Initializing Autostar (Autostar Models Only)

This exercise describes how to initialize Autostar.

Note: Normally, you will enter the Time and Date at the beginning of each observing session, but you will only perform the full Initialization procedure (i.e., entering the Location information and selecting the model number as well as entering the Time and Date) the first time you use Autostar or after performing a Reset.

1. Make sure that the telescope is assembled correctly, and that the batteries are installed as described previously.
2. Make sure the On/Off switch (D, Fig. 1e) is in the Off position. Plug Autostar's cord into the HBX port (A, Fig. 1e), as previously described. Push the On/Off switch to the On position.
3. A copyright message lights on Autostar's LCD display and a message warning not to look at the Sun scrolls across the display. Press the key prompted by Autostar to acknowledge the message has been read and understood.
4. The Getting Started menu displays a scrolling message with two choices:
 - a. Press and hold down the ? key (8, Fig. 2) for about 2 seconds for information on Autostar functions and controls. When finished, press MODE (3, Fig. 2) to exit Help, or,
 - b. Press ENTER (2, Fig. 2) to bypass the Help tutorial and continue with Initialization.
5. Autostar prompts you to enter the current date:
 - a. Press the Numbers keys (6, Fig. 2) to enter numbers 0 through 9. After the desired number is displayed, use the Right Arrow key (5, Fig. 2) to move the cursor from one number to the next in the day display (or use the Left Arrow key to move in the other direction across the display, if necessary).
 - b. Use the Right Arrow key (5, Fig. 2) to move the cursor to the month. Use the Scroll keys (7, Fig. 2) to cycle through the list of months. When the current month is displayed, use the Right Arrow (5, Fig. 2) to move the cursor to the year.
 - c. Use Number keys (6, Fig. 2) to enter all four digits of the current year. Use the Right Arrow key (5, Fig. 2) to move the cursor from one number to the next.
 - d. Press ENTER (2, Fig. 2) when the entire date has been entered.
6. Autostar then prompts you to enter the current time. Use the Number keys to enter digits. The Right and Left Arrow keys move the cursor across the screen as described in the previous step. Enter the current time (use a "0" for the first digit if less than 10). Use the Up Arrow key (7, Fig. 2) to scroll through "AM," "PM," or "blank." The "blank" option (screen displays neither AM nor PM) selects the 24-hour (i.e., military time) clock. Then press ENTER to start the clock.
7. Autostar then prompts you to enter the status of Daylight Savings Time. Press one of the Scroll keys to toggle between the YES/NO settings. Select the desired setting by pressing ENTER.

Note: Daylight Savings Time may be referred to by a different name in various areas of the world.
8. If you have previously entered the Country/State and City of your observing site (as described in **ACTIVATE THE ARROW KEYS**, page 16), go to step 9. If you have not entered this information, perform the following steps:

- a. Autostar prompts you to enter the Country or State (listed alphabetically) of the observing site. Use the Scroll keys to cycle through the database of countries, states, and provinces. Press ENTER when the correct location displays.
 - b. Autostar then prompts you to enter the nearest city (listed alphabetically) to the observing site. Use the Scroll keys to cycle through the database of cities. Press ENTER when the correct city appears on screen.
9. Autostar then prompts you to enter the model number of your telescope. Use the Scroll keys to cycle through the list of telescope models. Press ENTER when the correct model appears on the display.

Note: Autostar only prompts you to enter Country/State and City and model number the first time it is activated. These prompts do not appear again, unless you reset Autostar (see **RESET**, page 31). However, if you need to enter this information (e.g., you change your geographic location), you can do so by using the Site option of the Setup menu. See **ADDING OBSERVING SITES**, page 32, for detailed information.

10. System Initialization is complete and the display reads "Align: Easy." After performing the Initialization procedure, you MUST train your drive.

Training the Drive (Autostar Models Only)

Next, train the drive using Autostar. Perform this procedure the first time you use Autostar with your telescope, after a Reset, or if you are experiencing any pointing accuracy problems. Training the drive gives your telescope a higher degree of pointing accuracy.

Note: Use a terrestrial object, such as a telephone pole or lamp post, to train the drive. It is best to perform this procedure during the daytime.

1. If you have just performed **INITIALIZING AUTOSTAR**, go to step 2. If you have not yet initialized Autostar, go to page 19 and follow the procedure described in **INITIALIZING AUTOSTAR**. Then go to step 2 of this procedure.
2. Keep pressing MODE until "Select Item: Object" displays.
3. Press the Scroll Up key once. "Select: Item: Setup" displays.
4. Press ENTER to access the Setup menu. "Setup: Align" displays.
5. Keep pressing the Scroll Up key until "Setup: Telescope" displays.
6. Press ENTER to access the Telescope menu. "Telescope: Focal Length" displays.
7. Keep pressing the Scroll Down key until "Telescope: Train Drive" displays.
8. Press ENTER to choose the Train Drive option. "Train Drive: Az/RA Train" displays.
9. Press ENTER to begin Az/R.A. (Right Ascension) training.
10. "Drive Setup: For this..." begins to scroll across the display. This is a reminder to point your telescope at a terrestrial object. Loosen the R.A. and Dec. locks (17 and 33, Fig. 1d) and point the telescope at an object. Then re-tighten the locks. Press ENTER when the telescope is pointing at the desired terrestrial object.
11. "Center reference object" displays. Center your target object using the Arrow keys. When centered, press ENTER.
12. The telescope slews and "Press > until it is centered" displays. Press the Right Arrow key until the target is centered again. Then press ENTER.

Note: If you pass the object when pressing the Arrow key, you cannot slew the telescope back in the other direction. Press MODE until "Train Drive: Az/RA Train" displays and begin the procedure over again.
13. The telescope slews and "Press < until it is centered" displays. Press the Left Arrow key until the target is centered again. Then press ENTER.
14. "Train Drive: Az/RA Train" displays again. Press the Scroll Down key and "Train Drive: Alt/Dec Train" displays. Press ENTER to begin Alt/Dec. (Declination) training.

Note: Three other alignment methods, One-Star, Two-Star and Three-Star Polar alignment, are available as options in the "Setup: Align" menu. See page 51 and page 55 for more information.

Tip: The GO TO key also allows you to perform a "spiral search." A spiral search is useful when the telescope slews to an object, but that object is not visible in the eyepiece after the telescope finishes its search. (This sometimes occurs during an alignment procedure.)

Press GO TO when the telescope stops slewing. The telescope begins to move in a spiral pattern at a very slow speed (you may change the slew speed if you wish—see SLEW SPEEDS, page 16) around the search area. Look through the eyepiece and when the object does become visible, press MODE to stop the spiral search. Then use the Arrow keys to center the object.

15. "Drive Setup: For this..." begins to scroll across the display. This is another reminder to point your telescope at a terrestrial object. Loosen the R.A. and Dec. locks (17 and 33, Fig. 1d) and point the telescope at an object. Then re-tighten the locks. Press ENTER when the telescope is pointing at the desired terrestrial object.
16. "Center reference object" displays. Center your target object using the Arrow keys. When centered, press ENTER.
17. The telescope slews and "Press \uparrow until it is centered" displays. Press the Up Arrow key until the target is centered again. Then press ENTER.
18. The telescope slews and "Press \downarrow until it is centered" displays. Press the Down Arrow key until the target is centered again. Then press ENTER. "Train Drive: Alt/Dec Train" displays again. You have now completed this procedure. Continue onto the next procedure, EASY ALIGNMENT.

Easy Alignment (Autostar Models Only)

After completing the "Train the Drive" procedure, align your telescope using Autostar. The fastest and easiest way to start observing with Autostar's Go To capabilities is to align your telescope using the Easy Alignment.

1. Keep pressing MODE until "Select Item: Setup" is displayed. Press ENTER.
2. "Setup: Align" displays. Press ENTER. "Align: Easy" displays. Press ENTER.
3. "German North" displays and a scrolling message prompts you to set your telescope in the polar home position. See **SETTING THE POLAR HOME POSITION**, page 17, for a description of this procedure. Press ENTER after you finish the procedure.
4. Autostar then chooses two stars from its database to align upon. When the telescope slews to the star for alignment, it may not appear in the field of view in the eyepiece. Use the Arrow keys to move the telescope until the star is visible and centered in the eyepiece. The alignment star should be easily recognized and be the brightest star in the area of the sky where the telescope is pointing. See **WHICH ONE'S THE ALIGNMENT STAR**, page 18, for more information. When the star is centered, press ENTER. Repeat the procedure for the second alignment star.

Note: Autostar locates alignment stars based on the date, time, and location entered. The alignment stars may change from night to night. All that is required is for the observer to center the selected star in the eyepiece when prompted.

Go To Saturn (Autostar Models Only)

After performing the Train the Drive and the Easy Alignment procedures, the motor drive begins operating and the telescope is aligned for a night of viewing. Objects in the eyepiece should maintain (*i.e.*, track) their position even though the Earth is rotating beneath the stars.

Important Note: Once aligned, only use the Autostar menus or Arrow keys to move the telescope. Do not loosen the telescope locks, or move the base manually, or alignment will be lost.

This exercise demonstrates how to select an object for viewing from Autostar's database, *i.e.*, Saturn. Note that Saturn is not visible all year long and it may be necessary for you to choose another object from Autostar's database. However, the procedure will be identical to the one used for observing Saturn.

1. After the telescope is aligned, "Select Item: Object" displays. Press ENTER. If "Select Item: Object" is not currently displayed, press MODE repeatedly until it displays, then press ENTER.
2. "Object: Solar System" displays. Press ENTER.
3. "Solar System: Mercury" displays. Use the Scroll Down key until "Solar System: Saturn" displays.
4. Press ENTER. "Calculating" displays. Then "Saturn" and a set of coordinates displays. Saturn's (and other planets') coordinates change throughout the year.



Fig. 17: The planet Saturn is over 800 million miles from the Earth.

5. Press GO TO. "Saturn: Slewing..." displays and the telescope slews until it finds Saturn. You may need to use the Arrow keys to center Saturn precisely in the eyepiece. Autostar then automatically slews (moves) the telescope so that it tracks Saturn (or whatever other object you may have chosen). Saturn remains centered in the eyepiece.

Using the Guided Tour (Autostar Models Only)

This example demonstrates using "Tonight's Best" Guided Tour.

1. After observing Saturn, keep pressing MODE until "Select Item: Object" displays again.
2. Press the Scroll Down key twice. "Select Item: Guided Tour" displays.
3. Press ENTER. "Guided Tour: Tonight's Best" displays. Press ENTER.

Note: If you wish to try out other Guided Tours, press the Scroll Down key to scroll through other tour choices. When the tour you wish to select displays, press ENTER.

4. "Tonight's Best: Searching..." displays. After calculating, "Tonight's Best: Jupiter" displays.

Note: Different objects may be displayed on a tour list on any given night.

Press ENTER to display information about the object. Press GO TO to move the telescope to the object.

5. Press MODE to return to the Tour list. Press the Scroll keys to scroll through the list. Press ENTER when you find the next object you wish to observe.
6. Press and hold down MODE for two seconds to leave the Guided Tour menu.

BASIC AUTOSTAR OPERATION

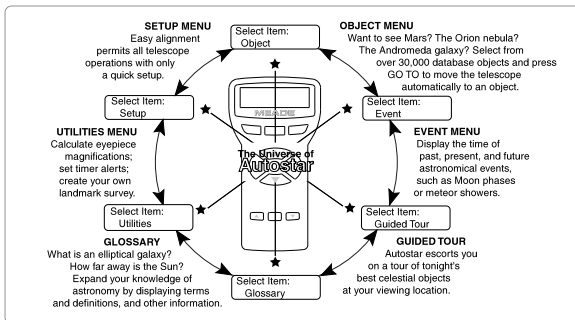

Fig. 18: The Autostar Universe. The six primary categories listed in the Select Item menu of Autostar.

It is important to understand that menu selections are set in a loop (Fig. 19). This means that pressing the Scroll Down key (7, Fig. 2) cycles down through all the available options within a given category, then returns to the first option. The Scroll Up key (7, Fig. 2) cycles up through the options in the opposite order. Note that this capability is a quick way to get to an option that is near the bottom of the list. The following example demonstrates this capability.

Example:

To navigate to the "Select Item: Setup" menu option when the "Select Item: Object" menu is displayed:

1. Press the Scroll Down key five times or the Scroll Up key once.

The screen in Fig. 20 displays two lines of information. The top line shows the current menu level. The second line displays an option which may be selected within that menu level. Some options are choices that select the next menu level down. The Scroll keys move up and down within the list of available options, showing one option at a time.

When the desired option is displayed on the second line, press the ENTER key to choose that option and move down one menu level.

Press the MODE key to leave a level; e.g., the wrong menu option is chosen.

Important Note: No matter how many levels into Autostar are traveled, each press of the MODE key moves up a level, until the top level, "Select Item," is reached. Once in the Select Item level, press MODE to return to the topmost level, "Select Item: Object."

Autostar Navigation Exercise

To demonstrate how the Autostar menu structure works, the following exercise calculates Sunset time so an evening observing session can be planned.

Note: Before proceeding with this exercise, Autostar must be properly initialized and aligned (see pages 19 and 21).

To Calculate Sunset time:

1. Press the MODE key several times, until "Select Item: Object" is displayed.
2. Press the Scroll Down key once to display the "Event" option in the "Select Item" menu.

Important Note: Some models are equipped with an Electronic Controller handbox, rather than the Autostar Handbox. The following sections (BASIC AUTOSTAR OPERATION, AUTOSTAR MENUS, AND USEFUL AUTOSTAR PROCEDURES), are relevant only to models equipped with the Autostar handbox and do not apply to the EC models. For more information about the EC handbox, see APPENDIX D: EC HANDBOX, page 62.

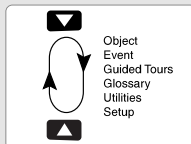

Fig. 19: Menus set in a loop.



Fig. 20: Menu options display on the second line. Use the Scroll keys to move up or down through the list of options. Press ENTER to select the desired option.

Tip: When multiple choices are available within a menu option, the current option is usually displayed first and highlighted by a right pointing arrow (>).

3. Press the ENTER key to choose the "Event" option and move down a level. "Event: Sunrise" is displayed.
4. Press the Scroll Down key once to display the "Sunset" option in the Event menu.
5. Press the ENTER key to choose the "Sunset" option and move down another level.
6. Autostar calculates the Sunset time based on the current date, time, and location. Autostar then displays the results of the calculation.
7. Press MODE once to start moving back up through the Autostar levels. The first level up is the Event menu.
8. Press MODE again to move up another level. This is the top level, "Select Item."
9. Press MODE again to return to the starting point of "Select Item: Object."

Entering Data into Autostar

- Use the Number keys to enter digits.
- Use the Arrow keys to scroll through numbers 0 through 9 and the alphabet. The Down Arrow key begins with the letter "A," the Up Arrow key begins with digit "9."
- To move the cursor across the display:
 - Use the Right or Left Arrow key (5, Fig. 2) to move the cursor from one number to the next in the display.
 - Press ENTER when the desired information has been entered.

Navigating Autostar

Autostar's menus are organized for quick and easy navigation:

- Press ENTER (2, Fig. 2) to go deeper into Autostar's menu levels.
- Press MODE (3, Fig. 2) to move back toward the top menu level.
- Press the Scroll keys (7, Fig. 2) to move up and down through the options or lists.
- Press the Arrow keys (5, Fig. 2) to move the cursor across the display.
- Press the Help (?) key (8, Fig. 2) to access on-line help.

LXD75 TIPS

Look into the Future

The Autostar Date option in the Setup menu is much more than just an entry of today's date; with it you can look far into the future or learn about past events. Autostar can calculate the date and times of future events and, except for eclipses, past events as well (based on the current calendar system). E.g., a Sunrise on March 6, 2043 A.D. or the Vernal Equinox in 1776 A.D. To use this feature, enter the desired date in the Setup: Date menu and select an option in the Event menu.

Autostar can calculate dates and times for Sunrises, Sunsets, Moonrises, Moonsets, Moonphases, Solar and Lunar Eclipses (for the next 100 years), meteor showers, equinoxes and solstices, and the minimums of Algol.

One very practical use of the Date and Time menus is to use the Sunset option to determine when you can begin your astronomical observing on any given evening.

AUTOSTAR'S MENUS

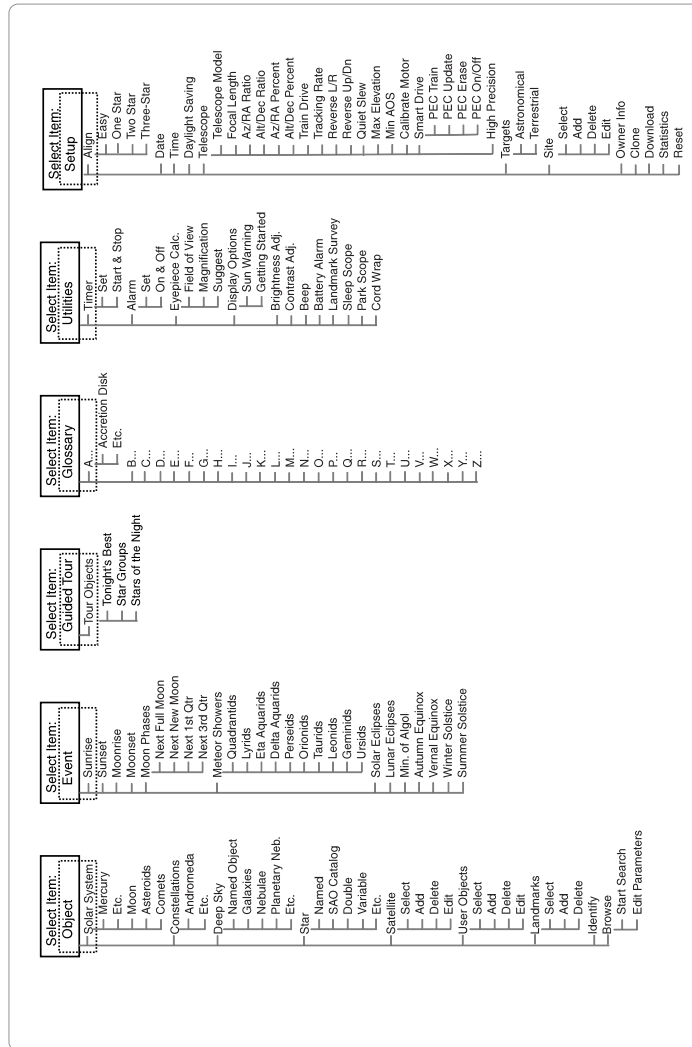

Fig. 21 The Complete Autostar Menu Structure.

MENUS

Object Menu

Almost all observing with Autostar is performed using the Object menu category. (*Note: Exceptions include Guided Tour and Landmark Survey.*) See **GO TO SATURN**, page 21, for an example of observing using the Object menu. Also see **USING THE GUIDED TOUR**, page 22.

Autostar contains many libraries of viewable objects, such as stars, planets, comets, nebulae and so forth. When one of these objects is selected from a library, Autostar moves your telescope (if properly aligned) and points it at the selected object.

The Object Menu options include:

Solar System is a library of the eight planets (Earth is not included) in order out from the Sun, followed by the Moon, asteroids, and comets.

Constellation is a library of all 88 Northern and Southern Hemisphere constellations. When this menu option is chosen and a constellation name appears on the first line of the screen, press GO TO once to change the second line to the name of the brightest star in the constellation. Press GO TO a second time to slew the telescope to that star. Use the Scroll keys to cycle through the list of stars in the constellation, from brightest to dimmest.

Deep Sky is a library of objects outside our Solar System such as nebulae, star clusters, galaxies, and quasars.

Star is a library of stars listed in different categories such as named, double, variable, or nearby.

Satellite is a library of Earth-orbiting objects such as the International Space Station, the Hubble Space Telescope, Global Positioning System (GPS) satellites, and geosynchronous orbit satellites.

User Objects allows the user to define and store in memory deep-sky objects of specific interest that are not currently in the Autostar libraries. See **Using Autostar to Find Objects Not in the Libraries**, page 33 for more information.

Landmarks stores the location of terrestrial points of interest in the permanent Autostar database.

Important Note: To use the Landmark function, the telescope must be located and aligned exactly as when the landmark was added to the database.

- **Select:** To select a Landmark already in the database (see **ADD** below), choose the "Select" option and scroll through the list. Press ENTER to select a Landmark, then press GO TO and the telescope slews to the object.

- **Add:** To add a Landmark, choose the "Add" option. Enter a name for the Landmark. Locate and center the Landmark in the eyepiece, then press ENTER.

Identify is an exciting feature for an observer who wants to scan the night sky and start exploring. After the telescope has been properly aligned, use the Autostar Arrow keys to move about in the sky. Then follow this procedure:

Important Note: Only use the Arrow keys to move the telescope during the Identify procedure. Do not loosen the telescope locks or move the base or alignment is lost.

1. When a desired object is visible in the eyepiece, keep pressing MODE until the "Select Item: Object" menu is displayed. Press ENTER to select this menu.
2. Scroll through the Object menu options until the "Object: Identify" screen appears.
3. Press ENTER. Autostar searches the libraries for the identity of the object being observed.
4. If the telescope is not directly on an Autostar library object, the nearest library object is located and displayed on the screen. Press GO TO and the telescope slews to that object.

Want to learn more about observing satellites?
See page 34.

Want to learn more about Landmarks?
See page 34.

Want to learn more about using the **Date menu**? See the **LXD75 TIPS** box, page 24.



WARNING!
Never use a Meade®

LXD75-Series Telescope to look at the Sun! Looking at or near the Sun will cause instant and irreversible damage to your eye. Eye damage is often painless, so there is no warning to the observer that damage has occurred until it is too late. Do not point the telescope or its viewfinder at or near the Sun. Do not look through the telescope as it is moving. Children should always have adult supervision while observing.

Browse allows you to search the library for objects with certain parameters, much like a search engine. "Edit Parameters" lets you set various parameters for the search, such as: Object Type, Minimum Elevation, Largest, etc. Once you have set the parameters of the search, select "Start Search" and press ENTER. Autostar will display the results of the search.

Event Menu

The Event menu provides access to dates and times of astronomical events. The Event database includes:

Sunrise and Sunset calculates the time that the Sun rises or sets on the current date. Find rise and set times for other dates by entering a new date into the "Setup: Date" menu.

Moonrise and Moonset calculates the time that the Moon rises or sets on the current date. Find rise and set times for other dates by entering a new date into the "Setup: Date" menu.

Moon Phases displays the date and time of the next Full, New, 1st Quarter, and 3rd Quarter Moon.

Meteor Showers provides information on upcoming meteor showers, such as the Perseids, the Leonids, etc. Also lists the dates of the showers and when they reach maximum.

Note: Meteors are fast moving objects that cover large areas of the sky and are usually best observed with the naked eye.

Solar Eclipse lists upcoming Solar Eclipses, including the date and type (total, annular, or partial) of eclipse, and the location and time of the first and last contacts of the Moon's shadow. Use the Scroll Up and Down keys to display the available data. Remember, never use a telescope to look at the Sun! See **WARNING!** to the left.

Lunar Eclipse lists upcoming Lunar Eclipses, including the date and type (total, partial, penumbral) of eclipse. Use the Scroll Up and Down keys to display the available data.

Min. (Minimum) of Algol is the minimum brightness of the dramatic eclipsing binary star system, Algol. It is relatively close at a distance of 100 light years. Every 2.8 days during a 10-hour period, Algol undergoes a major change in apparent magnitude as one of the two stars passes behind the other. The combined magnitude of the two stars thus dips from +2.1 to a minimum of +3.4 halfway through the eclipse as the second star is hidden. Autostar calculates minimum magnitude time at mid-eclipse.

Autumn and Vernal Equinox calculates the time and date of the fall or spring equinox of the current year.

Winter and Summer Solstice calculates the time and date of the winter or summer solstice of the current year.

Glossary Menu

The Glossary menu provides an alphabetical listing of definitions and descriptions for common astronomical terms and Autostar functions. Access directly through the Glossary menu or through hypertext words embedded in Autostar. A *hypertext word* is any word in [brackets], usually found when using the Autostar Help function or when reading a scrolling message such as a description of a planet or star. Press ENTER whenever a hypertext word is on screen and Autostar goes to the glossary entry for that word.

To access directly from the Glossary menu, use the Scroll keys to scroll through the alphabet. Press ENTER on the desired letter. Scroll to the desired entry and then press ENTER to read the description.

Utilities Menu

The Utilities menu provides access to several extra features within Autostar, including a countdown timer and an alarm. The Utilities functions include:

Timer selects a countdown timer. This feature is useful for functions such as astrophotography and tracking satellites. To use the Timer, press ENTER, then choose "Set" or "Start/Stop."

Tip:
If you notice that the text is "smearing" on the Autostar display, use the contrast adjustment menu.

Want to learn more about **Landmarks**? See page 34.

■ **Set:** Enter the time to be counted down, in hours, minutes, and seconds, then press ENTER.

■ **Start/Stop:** Activates the timer set previously. Use the Scroll keys to toggle between ON and OFF. When ON is displayed, press ENTER to activate the timer. When the timer runs out, four beeps sound and the timer is deactivated.

Alarm selects a time for an alarm signal as a reminder. To use the Alarm, press ENTER, then choose "Set" or "Start/Stop."

■ **Set:** Enter the time of day for the alarm to sound, in hours, minutes, and seconds, then press ENTER.

■ **Start/Stop:** Activates the alarm set previously. Use the Scroll keys to toggle between on and off. When ON is displayed, press ENTER to activate the alarm. When the alarm time arrives, Autostar beeps. Press ENTER to deactivate the alarm.

Eyepiece Calc calculates information about an eyepiece for the specific telescope to which Autostar is connected.

■ **Field of View:** Scroll through a list of available eyepieces. When an eyepiece is selected, the field of view is calculated.

■ **Magnification:** Scroll through a list of available eyepieces. When an eyepiece is selected, the magnification is calculated.

■ **Suggest:** Autostar calculates and suggests the best eyepiece for viewing, based on the telescope and the object being viewed.

Display Options enables or disables Autostar's two initial displays. If both displays are disabled, Autostar begins with the Date display.

■ **Sun Warning:** Turns the "Sun Warning" message on or off.

■ **Getting Started:** Turns the "Getting Started" message on or off.

Brightness Adj: Adjusts the brightness of the display using the Scroll keys. When complete, press ENTER.

Contrast Adj: Adjusts the contrast of the display using the Scroll keys. When complete, press ENTER. The Contrast Adjustment feature is usually only required in very cold weather.

Beep: Turns the beep on or off.

Landmark Survey automatically slews the telescope to all user-defined landmarks with a short pause at each location. Press ENTER to start the survey. While a slew is in progress, press any key to skip that object and go to the next landmark on the list. To observe a landmark for a longer period, press MODE when paused on the object to stop the survey. Press ENTER to restart the survey at the first object on the list.

Sleep Scope is a power saving option that shuts down Autostar and the telescope without forgetting its alignment. With "Sleep Scope" selected, press ENTER to activate the Sleep function. Autostar goes dark, but the internal clock keeps running. Press any key, except ENTER, to re-activate Autostar and the telescope.

Park Scope is designed for a telescope that is not moved between observing sessions. Align the telescope one time, then use this function to park the telescope. Next time it is powered up, enter the correct date and time – no alignment is required. Pressing ENTER causes the telescope to move to its pre-determined Park position. Once parked, the screen prompts to turn off power.

Important Note: When the "Park Scope" option is chosen and the display prompts you to turn off the telescope's power, Autostar is unable to be returned to operation without turning the power off and then back on.

Cord Wrap moves the telescope in such a way as to prevent the cords and cables attached to your telescope assembly from getting wound around the assembly and tangled as the telescope slews to objects. This menu is set to "On" and cannot be changed by the user.

Setup Menu

The Setup menu's primary functions are for setting up telescope alignment. However, there are numerous other features available within the Setup menu, including:

Date changes the date used by Autostar. This function is useful to check events in the past or future. For example, set the Date menu for a day three months in the future.

Want to learn more about using the **Date menu**? See the **LXD75 TIPS** box, page 24.

Then check the "Select Item: Event" menu for the Sunset time on that date. See **EVENT MENU**, page 27.

TIME changes the time entered into Autostar. Setting the correct time is critical for Autostar to properly calculate locations and events. Time may be set to 24-hour mode (military time) by selecting the "blank" option (*i.e.*, no option is displayed) which follows the "AM" and "PM" options.

Daylight Saving is used to enable or disable Daylight Savings time.

Note: *Daylight Savings Time may be referred to by different names in various areas of the world. Check local time to verify.*

Telescope accesses several options, including:

- **Telescope Model:** Allows you to select the telescope model connected to Autostar.
- **Focal Length:** Displays the focal length of the selected telescope.
- **Az/R.A. Ratio and Alt/Dec. Ratio:** The Az (Azimuth) or the R.A. (Right Ascension) ratio and Alt (Altitude) or Dec. (Declination) ratio refers to the gears of the telescope's motors. Do not alter these numbers.
- **Az/R.A. Percent:** This option allows you to change the AZ (azimuth) or R.A. (right ascension) backlash, *i.e.*, the way the Arrow keys move the telescope along the azimuth or R.A. axes. If you enter a value near 100, the telescope tube responds more quickly (it responds immediately at 100%) as you hold down an Arrow key and also slews (moves) the tube more quickly. If you enter a value near 0, it takes longer for the tube to respond as you hold down an Arrow key and also slews the tube more slowly. Experiment with this option. Try changing the percent value until you get a "feel" for the Arrow keys that is comfortable for you.
- **Alt/Dec. Percent:** The option operates identical to the Az/R.A. Percent option (see above), but allows you to change the altitude or declination backlash, *i.e.*, the way the telescope responds to the Arrow keys when moving along the altitude or declination axes.
- **Train Drive:** Trains the Altitude/Declination and Azimuth/R.A. motors to locate objects with more precision.
- **Tracking Rate:** Changes the speed at which the telescope tracks targets in the sky.
 - a. **Sidereal:** The default tracking setting for Autostar; sidereal rate is the standard rate at which stars move from East to West across the sky due to the rotation of the Earth.

Want to learn more about **Training the Drive**? See the **LXD75 TIPS** box, page 20.

LXD75 TIPS

Observing Considerations

- Try to pick an observing site away from street and house lights and car headlights. While this is not always possible, the darker the site, the better.
- Give your eyes about ten minutes to adjust to the darkness before observing. Give your eyes a rest from observing every ten or fifteen minutes to relieve eyestrain.
- Try not to use a standard flashlight. Experienced observers use red LED flashlights, the red utility light on the Autostar handbox, or tape red cellophane over their flashlights to use for setup and map reading so they don't have to continually readjust their eyes to the darkness. Be careful not to shine bright lights if there are other observers in the area. Do not shine a flashlight into the telescope while someone is observing!
- Dress warmly. It gets chilly when you're sitting for prolonged periods.
- Practice setting up your equipment during the day or in a lighted area to become familiar with it before going to a dark site.
- Use your 26mm eyepiece to view terrestrial objects and wider areas of space, such as open star clusters. Use an optional 9mm eyepiece when you wish to view something up close, such as craters on the Moon or the rings of Saturn.
- Know your observing site. If you're going to try out an unfamiliar site, check it out in the daylight for possible obstructions and pitfalls.

Tip:
The Reverse L/R and U/D functions are useful if you are observing in the Southern hemisphere.

Do you want to learn how to perform the **periodic error correction procedure**? See **SMART DRIVE**, page 56.

Tip:
If the "ENTER to Sync" feature is accessed by mistake (holding the ENTER key for more than 2 seconds), press **MODE** to return to the previous screen.

Want to learn more about **adding and editing sites**? See page 32.

Time Zone	Shift
Atlantic	-4 Hours
Eastern	-5 Hours
Central	-6 Hours
Mountain	-7 Hours
Pacific	-8 Hours
Alaska	-9 Hours
Hawaii	-10 Hours

Table 1: Time Zone Shift.

- b. **Lunar:** Choose this option to properly track the Moon over long observing sessions.
- c. **Custom:** Allows entry of user-defined tracking rates.

- **Reverse L/R:** Reverses the functions of the Left and Right Arrow keys (*i.e.*, the Right key moves the telescope to the left).
- **Reverse U/D:** Reverses the functions of the Up and Down Arrow keys (*i.e.*, the Up key moves the telescope down).
- **Quiet Slew:** Sets the maximum slew rate to 1.5° for quieter operation.
- **Max Elevation:** Allows you to enter a value in degrees that sets a limit as to how far the optical tube can swing upward during a programmed slew. (Note that it does not prevent you from performing a manual slew past this limit.) This is useful when you have a camera or other peripheral attached to the telescope—you can prevent it from striking the telescope base.
- **Min AOS (Acquisition of Signal):** Allows you enter a value in degrees. This value represents the altitude at which your telescope begins to slew when acquiring a satellite track. This is useful when you are observing satellites, but a tall tree or building is obstructing the telescope. For example, you might begin to track the satellite at 15° altitude, instead of 5°. See **OBSERVING SATELLITES**, page 34, for more information about satellites.
- **Calibrate Motor:** If the telescope motors appear to have a problem, use this option to retest the motors before performing a Reset. This option is also used if an Autostar unit is moved between telescopes, to match Autostar to the new telescope. To calibrate the motors, select this option and press ENTER.
- **Smart Drive:** Allows you to perform periodic error correction (PEC) on the R.A. drive worm gear. Must be performed with a high-power reticle (*eg.*, 9mm).
- **High Precision:** If High Precision is turned on, when looking for a faint celestial object (*i.e.*, a nebula or galaxy), Autostar first slews to a nearby bright star and displays "ENTER to Sync." Center the star in the eyepiece, then press ENTER. At that point the telescope has a high precision alignment to that part of the sky and it then slews to the object that was originally requested.

Targets switches between Astronomical targets and Terrestrial targets. If "Astronomical" is selected, the telescope tracking motor is activated and any object you observe will remain centered in the eyepiece. If "Terrestrial" is selected, the tracking motor is turned off. To learn how to track an object automatically, see page 18.

Site provides access to several options including:

- **Select:** Displays the currently selected observing site. Use the Scroll keys to cycle through all available sites (see **ADD** below). Press ENTER when the site you wish to select displays. Use this option when you move to a different geographic location.
- **Add:** Allows you to add new observing sites to the database (up to six sites may be stored). Scroll through the list of Countries/States. Press ENTER when the site you wish to add displays. Then choose the desired city in the same manner.
- **Delete:** Deletes a stored site from the database.
- **Edit:** Edits a selected site, including: the name, latitude, longitude, and time zone. Time Zone refers to the Greenwich Mean Time (GMT) time zone shift. Users West of Greenwich, England use "-" hours. East of Greenwich use "+" hours. For the United States, look up the time zone shift in **Table 1**.

Note: *Autostar compensates for daylight savings time, if selected. See **SETUP MENU: DAYLIGHT SAVING**, page 29.*

Owner Info accesses the owner information menu, including:

- **Name:** Users may enter both their first and last names using the Up and Down Arrow keys to cycle through the alphabet. Use the Right and Left Arrow keys to move through the text. Press ENTER when the entry is complete.
- **Address:** Use the Up and Down Arrow keys to enter your street address, city, state, and zip code. Press ENTER when the entry is complete.

Note: The Download and Clone functions require the optional #505 Astrofinder Software and Cable Connector Kit. See the instruction sheet included with the kit for more information on how to download.

Download transfers information from another Autostar. During the operation, the warning "Downloading Do Not Turn Off" appears.

Clone uploads information from one Autostar handbox to another. Three options are available:

- **Catalogs:** Sends only user-defined object information, such as new satellite orbits or comet data to another Autostar handbox.
- **Software:** Sends only the basic Autostar software. This is useful if one user has downloaded a new version of Autostar software from the Meade website (www.meade.com) and wants to pass this software along to friends.
- **All:** Everything—user-defined information and Autostar software—is sent to another Autostar.

Statistics provides basic statistical data about Autostar, including:

- **Characters Free:** Shows how much room is available in user-defined object memory.
- **Version:** Shows the current version of the Autostar software.

Reset completely resets Autostar. Most values entered into the menus revert to factory defaults. Autostar requires initialization after a Reset before proceeding with observations. See **INITIALIZING AUTOSTAR**, page 19.

LXD75 TIPS

Surf the Web

One of the most exciting resources for astronomy is the internet. The internet is full of websites with new images, discoveries, and the latest astronomical information. For example, when comet Hale-Bopp made its approach to our Sun in 1998, astronomers around the world posted new photos daily.

You can find websites for almost any topic relating to astronomy on the internet. Try the following key word searches: NASA, Hubble, HST, astronomy, Messier, satellite, nebula, black hole, variable stars, etc.

Check out Meade's website for the latest product and technical information. You can download the latest software revisions, links to other astronomical sites, coordinates of celestial objects and the latest satellite tracking information for your Autostar handset. See page 34 for more information. You'll find our website at:

<http://www.meade.com/>

Here are some other sites you might find interesting:

- *Sky & Telescope:*
<http://www.SkyandTelescope.com>
- *Astronomy:*
<http://www.astronomy.com>
- *The Starfield:*
<http://users.nac.net/gburke/>
- *Astronomy Picture of the Day:*
<http://antwrp.gsfc.nasa.gov/apod>
- *Heavens Above (satellite observing information):*
<http://www.heavens-above.com>
- *Photographic Atlas of the Moon:*
http://www.lpi.ursa.edu/research/lunar_orbiter
- *Hubble Space Telescope Public Pictures*
<http://oposite.stsci.edu/pubinfo/pictures.html>

USEFUL AUTOSTAR PROCEDURES

Before trying out the examples in this section, familiarize yourself with the basic operations of Autostar described earlier in this manual. The following examples assume that you have a basic knowledge of Autostar and understand how to scroll to a desired menu or menu option, and how to enter numbers and text. It also assumes that you have initialized and aligned your telescope.

Adding Observing Sites

If you plan to observe using Autostar at different geographic locations, you can store up to six observation sites in Autostar's memory to help simplify your telescope setup. Perform these procedures using the Site options (Add, Select, Delete, Edit) of the Setup menu.

To Add a Site to the user-defined site list:

In this example, you will choose a city and add it to the database list. You will then select the site to enable it.

1. Navigate to the "Setup: Site" menu. Press ENTER.
2. Scroll through the options until "Site: Add" displays. Press ENTER.
3. Scroll through the list of countries/states. Press ENTER when the country/state you wish to add displays.
4. Scroll through the list of cities. Press ENTER when the city you wish to add displays. The Site is now added to the database. You may add 5 sites using this method (the sixth site is the site you added during the manual initialization process).
5. To choose a site, navigate to "Setup: Select." Press ENTER. Scroll through the list of sites. When the desired site displays, press ENTER.

To Edit a Site

In this procedure, you will enter a location that is not available in the Autostar database by editing data of a nearby site. You will edit the location's name, latitude, longitude and the time zone shift. You will then select the site to enable it.

You will need to know the latitude and longitude of your location to perform this procedure.

1. Using the Add option, choose a site on the list that is closest to your observing site and press ENTER so that the site is added to your observing sites list. Choosing a site already on the list (as opposed to using the "Custom" feature) makes it easier to edit, as the "Time Zone" value may not need to be changed.
2. Scroll to "Site: Edit" and press ENTER. "Edit: Name" displays. Press ENTER.
3. The name of the site you have just entered to your list displays; if it does not, scroll to the site.
4. Using the Arrow keys, change the name of the site so that it now reads the name of your observing location. Press ENTER. "Edit: Name" displays again.
5. Press the Scroll Down key and "Edit: Latitude" displays. Press ENTER.
6. Using the Number Keys, enter the latitude of your observing site and then press ENTER. "Edit: Latitude" displays again.
7. Press the Scroll Down key and "Edit: Longitude" displays. Press ENTER.
8. Using the Number Keys, enter the longitude of your observing site and then press ENTER. "Edit: Longitude" displays again.
9. Press the Scroll Down key and "Edit: Time Zone" displays. Press ENTER. (If the site you chose from the list in step 1 has the same Time Zone as the site you are editing, just press ENTER again to go on to the next step.) "Time Zone" refers to the Greenwich Time Zone shift. Users West of Greenwich, use "-" hours (one hour per time zone) and users East of Greenwich use "+" hours. For the United States, look up the shift in **TABLE 1**, at the left.
10. After entering the shift, press ENTER. "Edit Time Zone" displays.

Time Zone	Shift
Atlantic	-4 Hours
Eastern	-5 Hours
Central	-6 Hours
Mountain	-7 Hours
Pacific	-8 Hours
Alaska	-9 Hours
Hawaii	-10 Hours

Table 1: Time Zone Shift.

11. Press MODE. "Site: Edit" displays.
12. Using the Arrow keys, scroll to "Site: Select." The site you have just edited displays. Press ENTER to select the site or press MODE to exit.

Using Autostar to Find Objects Not in the Libraries

In this procedure, you will enter coordinates of celestial objects that do not appear in any of the Autostar libraries. You will enter the object's name and R.A. and Dec. coordinates (required information). You may also enter the object's magnitude and size (optional information).

Although Autostar contains an extensive database of celestial objects (stars, nebulae, planets, etc.) that you can observe, you may eventually want to view objects that are not part of a library. Autostar provides a feature that allows you to enter an object's R.A. and Dec. coordinates in the "User: Objects" option of the Object menu and allows automatic slewing of the telescope to the user-entered coordinates.

In order to use this menu option, you first need to look up the R.A. and Dec. coordinates of the object or objects you wish to observe. Check out your local library, computer store, or bookstore for astronomy books, CD Roms, or magazines (such as *Sky & Telescope* or *Astronomy*), to find coordinates of celestial objects. The objects/coordinates you enter become part of your own permanent database, called "User Objects."

To enter coordinates of an object into the "User: Objects" option of the Object menu:

1. Make sure Autostar has been initialized and the telescope has been aligned.
2. After the telescope is aligned, "Select Item: Object" displays. (If necessary, use the Scroll keys to scroll through the menus, as previously described, to find this option.) Press ENTER.
3. "Object: Solar System" displays. Keep pressing the Scroll Up key until "Object: User Object" displays and press ENTER.
4. "User Object: Select" displays. Press the Scroll Down key once. "User Object: Add" displays. Press ENTER.
5. "Name" displays on the top line and a blinking cursor on the second line. Use the Arrow keys, as previously described, to enter the name of the object you wish to add to the database. When you are finished, press ENTER.
6. "Right Asc.: 00.00.0" displays. Use the Number keys to enter the digits for the Right Ascension coordinate of your object. When you are finished, press ENTER.
7. "Declination: +00°.00'" displays. Use the Number keys to enter the digits for the Declination coordinate of your object. If necessary, use the Scroll Keys to change "+" to "-." When you are finished, press ENTER.
8. Autostar then prompts you to enter the size of the object. This step is optional. Use the Number keys to enter the size (in arc-minutes), if so desired, and press ENTER to go to the next display. If you do not wish to enter this information, simply press ENTER.
9. Autostar then prompts you to enter the magnitude of the object. This step is also optional. Use the Number keys to enter this information, if so desired, and press ENTER to go to the next display. "User Object: Add" displays again.

To GO TO a user-entered object

In this procedure, you will choose an object from the User Object list and GO TO the object.

1. With "User Object: Add" displayed, press the Scroll Up key once. "User Object: Select" displays. Press ENTER.
2. Use the Scroll keys (if necessary) to scroll to the desired object. Press ENTER.
3. The name of the object and the Right Ascension and Declination coordinates display.
4. Press GO TO and the telescope slews to the object.

Tip: Entering R.A. and Dec. Coordinates of an object without using the menus:

If you do not wish to navigate through the menus, a more direct way to enter coordinates is to press and hold MODE for two seconds or more. R.A. and Dec. coordinates display. Press GO TO. "Object Position" and a set of coordinates displays. Enter the R.A. and Dec. coordinates of any celestial object using Number keys, overwriting the coordinates currently displayed. As soon as the coordinates are entered, Autostar slews the telescope to the coordinates. Note that the telescope must be initialized (see page 19), placed in the Home position (see page 17), and aligned (see page 21) for this procedure to operate properly.

However, if you wish to store the coordinates of an object in memory, use the method described at the right.

Tip:
To easiest way to get satellite information is to go to the Meade website and click "Autostar Update" in the Customer Support section. Follow the on-screen instructions to automatically download the information to your Autostar handbook.

The optional #505 Astrofinder Software and Cable Connector Kit is required to use the Autostar Update Utility.

Tip:
To use the Landmark function, the telescope must be located and aligned exactly as when the landmark(s) was added to the database.

Observing Satellites

In this procedure, you will prepare your telescope to observe a satellite pass.

1. Navigate to the "Object: Satellite" menu option and press ENTER.
 2. Use the Scroll keys to scroll through the list of satellites.
 3. Select a satellite from the list and press ENTER.
 4. "Calculating...." and then "Tracking..." displays. If the satellite is going to make a pass, "Located" displays.
 5. Use the Scroll keys to display data about the pass: aos – acquisition of signal and los – loss of signal. If you subtract the aos from the los, you can calculate how long the satellite will be visible. Location information also displays.
 6. "Alarm" displays after the location information. Press ENTER and Autostar automatically sets the alarm to sound a minute before the satellite's scheduled appearance. You may return to regular observations until the alarm goes off.
 7. When the alarm goes off, return to the Satellite menu and press a Scroll key until the desired satellite is on the top line of the display.
 8. Press GO TO. Autostar slews the telescope to where the satellite should appear. The motor drive stops and a countdown is displayed.
- Note:** *If the scheduled appearance position of the satellite is obstructed (i.e., by a building, tree, or hill), press ENTER and Autostar starts to move the telescope along the expected satellite track. When the track clears the obstruction, press ENTER again to pause the telescope, then continue with this procedure.*
9. With about 20 seconds left on the countdown timer, start watching through the telescope viewfinder for the satellite to enter the field of view.
 10. When the satellite enters the viewfinder field of view, press ENTER. The telescope starts to track with the satellite.
 11. Use the Autostar Arrow keys to center the object in the viewfinder, then look through the eyepiece to view the object.

Satellite orbits change and new satellites (including the Space Shuttle) are launched. Visit the Meade website (www.meade.com) approximately once a month to get updated information and instructions on how to download this data to Autostar. If orbital parameters are more than one month old, the satellite pass may not happen at the time predicted by Autostar. Downloading requires the optional #505 AstroFinder™ Software and Cable Connector Kit. See **OPTIONAL ACCESSORIES**, page 38.

Note: *Satellite observing is an exciting challenge. Most satellites are in low orbit, travelling at approximately 17,500 mph. When visible, they move quickly across the sky and are only in the field of view for a few minutes, requiring Autostar to slew the telescope rapidly. Best viewing is near Sunrise or Sunset when the sky is still dark. Viewing in the middle of the night can be problematic because the satellite may pass overhead, but not be visible as it is in the Earth's shadow.*

Landmarks

This menu option allows you to define and store terrestrial objects in the Landmark database. First, a landmark needs to be stored in memory using the "Landmark: Add" option. To view a landmark, use the "Landmark: Select" option. Landmarks may also be viewed using the "Landmark Survey" option in the Utilities menu.

To Add a landmark to the database:

In this procedure, you will store the location of terrestrial landmarks in Autostar's memory.

1. Note for future reference where the telescope is located. Select an easily recognizable reference object and center the object in the telescope eyepiece. Each time you wish to view landmarks you have added to the database, setup the telescope in this location and center the reference object in the eyepiece. If you do not use a consistent point of reference, the telescope will not be able to locate the objects you have added to the database.

Another setup method is to select an object from the Landmark database. See **TO SELECT A LANDMARK FROM THE DATABASE** below. Then manually move the telescope's optical tube and center this object in the telescope eyepiece.

2. Display the "Setup: Targets" menu option. Choose "Terrestrial" and press ENTER. "Setup: Targets" displays again. Choosing this option turns off tracking for astronomical objects which is not useful for the viewing of terrestrial objects such as those in the Landmark database. Be sure to change this option back to "Astronomical" when you wish to view celestial objects again.
3. Press MODE once. "Select Item: Setup" displays.
4. Press the Scroll Down key once and "Select Item: Object" displays. Press ENTER. "Object: Solar System" displays.
5. Press the Scroll Up key twice and "Object: Landmarks" displays. Press ENTER. "Landmark: Select" displays.
6. Press the Scroll Down key once. "Landmark: Add" displays. Press ENTER.
7. "Landmark Name" displays. Using Arrow keys, enter a name for the landmark you wish to add to the database. When finished, press ENTER.
8. "Center Landmark. Press Enter" displays. Using only the Arrow keys (do not manually move the telescope), move the telescope to the desired landmark and center the object in the eyepiece. Press ENTER. The object is now stored in memory.
9. "Landmark: Add" displays. If you wish to add more landmarks, repeat steps 5 through 7.

To Select a landmark from the database

1. Make sure the telescope is located and aligned exactly as when the desired landmark was entered into memory.
2. Display the "Landmark: Select" menu option. Press ENTER.
3. Use the Scroll keys to scroll through the list of objects you have previously entered. When the desired object displays, press ENTER to select the object.
Use the Scroll keys to scroll through location information about the object, if desired. Press GOTO to slew the telescope to the landmark.
4. Press MODE to exit.

To perform a Landmark Survey

This procedure allows you to perform a tour of the objects entered in the "Object: Landmark" menu option—note that the Landmark Survey will function only if you have previously entered objects in the Landmark menu.

1. Navigate to the "Utilities: Landmark Survey" menu and press ENTER.
2. "Landmark Survey: Slewing..." displays. The telescope moves to the first object on the Survey list and displays the name of the object.
3. Press MODE to pause the Survey, Press ENTER to restart the survey at the first object of the survey.

To Check on the Available Memory

Autostar has a limited amount of memory. Once you begin to store Landmarks, user objects and other bits of information in Autostar, you will begin to use up memory. This procedure allows you to check on how much memory is still available.

1. Navigate to the "Setup: Statistics" menu option and press ENTER.
2. "Statistics: 37.2K Char. Free" displays. This is the amount of memory that is still available to the user.

PHOTOGRAPHY

Photography through an LX75 Series Schmidt-Newtonian and Newtonian Reflector telescope requires an LX75-Series T-Adapter (supplied) attached to the telescope (Fig. 22a). Through-the-telescope photography is possible with any 35mm camera body with a removable lens. In this way, the telescope effectively becomes the lens of the camera.

Unthread the focuser extension tube (Fig. 22b) from the focuser drawtube to remove from the focuser assembly. The T-Adapter (2, Fig. 22a) threads onto the focuser, followed by the camera body (1, Fig. 22a).

To orient an object in the viewfinder of the 35mm camera body, use a small jeweler's screwdriver to slightly loosen three adjustment screws around the outer knurled ring of the T-Adapter. Rotate the camera body to achieve proper orientation of the object; then re-tighten the adjustment screws.

Photography through a long lens such as the LX75-Series requires special technique for good results, and the photographer should probably expect to waste a roll or two of film in acquiring this technique. Long-lens photography has its own rewards, however, rewards that short-focus lenses cannot duplicate.

A few tips on photography with the LX75-Series telescopes:

1. Use a cable-operated shutter release. Touching the camera body to initiate shutter operation almost certainly introduces undesirable vibrations.
2. Focus the image with extreme care. While observing the subject through the camera's reflex viewfinder, turn the telescope's focus knob (3, Fig. 22a) to achieve the sharpest possible focus. Note that some 35mm cameras may have an optional focusing screen (available from the manufacturer) for use with a long telephoto lens. This screen provides a brighter and clearer image to focus, and is highly recommended.
3. Correct shutter speeds vary widely, depending on lighting conditions and film used. Trial-and-error is the best way to determine proper shutter speed in any given application.

Note: The camera used with your telescope may have an exposure meter that is still active when the standard lens is removed and the body is connected to the telescope with the T-Adapter. If used for terrestrial photography, the camera meter should be acceptable. If used for astrophotography, the meter probably will not provide good results since camera meters are not made to compensate for a dark sky.

4. Terrestrial photography through the LX75-Series is sensitive to heat waves rising from the Earth's surface. Long distance photography is best accomplished in the early morning hours before the earth has had time to build up heat.
5. Photography of the Moon and planets through the LX75-Series can be especially gratifying, but points 1 through 4 should be particularly noted in this case.

Photography with Meade's Autostar Suite™

The Autostar Suite with Meade LPI™ (Lunar Planetary Imager) and Planetarium software turns your Meade LX75 telescope, Autostar and PC into even more powerful astronomical instrument. LPI (Lunar Planetary Imager, Fig. 23) combines the power of an electronic astronomical imager with the simplicity of a web cam.

- Achieve great results the first time out on the Moon, planets, brighter deep-sky objects and terrestrial targets.
- Easy to use with real-time display of object on your PC screen. Just center, focus and shoot.
- Magic Eye software-assisted focusing.

The Autostar Suite Software includes powerful tools to help you get the most from your Meade LX75 telescope:

- Sophisticated planetarium program with over 19 million objects.
- Select objects from the 19 million objects in the planetarium display and the telescope slews to those objects.
- Create your own Guided Tours.

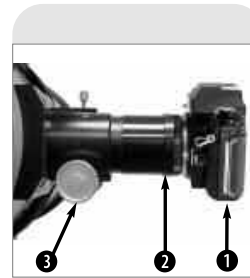

Fig. 22a: LX75-Series T-Adapter attached to focuser assembly and camera. (1) Camera Body, (2) T-Adapter, (3) Focus Knob.

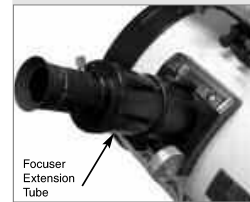

Fig. 22b: Focuser Extension Drawtube with eyepiece holder and eyepiece attached.



Fig. 23: The Lunar Planetary Imager.

OPTIONAL ACCESSORIES

A wide assortment of professional Meade accessories is available for the LXD75-Series telescope models. The premium quality of these accessories is well-suited to the quality of the instrument itself. Consult the Meade General Catalog for complete details on these and other accessories.



Fig. 24: Series 4000 Eyepieces.



Fig. 25: #140 2x Barlow Lens.



Fig. 26: #905 Variable Polarizer.



Fig. 27: Series 4000 8 - 24mm Zoom Eyepiece.

Eyepiece/Apparent Field	6" f/5	8" f/4	10" f/4
	Power/Actual Field	Power/Actual Field	Power/Actual Field
Super Plössl Eyepieces (4-elements; 1.25" O.D.)			
6.4mm/52°	119/0.44°	127/0.41°	159/0.33°
9.7mm/52°	79/0.66°	84/0.62°	105/0.50°
12.4mm/52°	61/0.85°	65/0.79°	82/0.63°
15mm/52°	51/1.02°	54/1.96°	68/0.77°
20mm/52°	38/1.36°	41/1.28°	51/1.02°
26mm/52°	29/1.77°	31/1.67°	39/1.33°
32mm/52°	24/2.18°	25/2.05°	32/1.64°
40mm/44°	19/2.31°	20/2.17°	25/1.73°
Super Wide Angle Eyepieces (6-elements; 1.25" O.D., except as noted)			
13.8mm/67°	55/1.21°	59/1.14°	74/0.91°
18mm/67°	42/1.58°	45/1.49°	56/1.19°
24.5mm/67°	31/2.15°	33/2.02°	41/1.62°
32mm/67° (2" O.D.)	24/2.81°	25/2.64°	32/2.11°
40mm/67° (2" O.D.)	19/3.52°	20/3.30°	25/2.64°
Ultra Wide Angle Eyepieces (8-elements; 1.25" O.D., except as noted)			
4.7mm/84°	162/0.52°	173/0.49°	216/0.39°
6.7mm/84°	114/0.74°	121/0.69°	152/0.55°
8.8mm/84° (1.25" - 2" O.D.)	87/0.97°	92/0.91°	115/0.73°
14mm/84° (1.25" - 2" O.D.)	54/1.54°	58/1.45°	73/1.16°

Eyepiece/Apparent Field	5" f/9.3	6" f/8	8" f/10
	Power/Actual Field	Power/Actual Field	Power/Actual Field
Super Plössl Eyepieces (4-elements; 1.25" O.D.)			
6.4mm/52°	184/0.28°	188/0.28°	313/0.17°
9.7mm/52°	122/0.43°	124/0.42°	206/0.25°
12.4mm/52°	95/0.55°	97/0.54°	161/0.32°
15mm/52°	79/0.66°	80/0.65°	133/0.39°
20mm/52°	59/0.88°	60/0.87°	100/0.52°
26mm/52°	45/1.15°	46/1.13°	77/0.68°
32mm/52°	37/1.41°	38/1.39°	63/0.83°
40mm/44°	30/1.49°	30/1.47°	50/0.88°
Super Wide Angle Eyepieces (6-elements; 1.25" O.D., except as noted)			
13.8mm/67°	86/0.78°	87/0.77°	145/0.46°
18mm/67°	66/1.02°	67/1.01°	111/0.60°
24.5mm/67°	48/1.39°	49/1.37°	82/0.82°
32mm/67° (2" O.D.)	37/1.82°	38/1.79°	63/1.07°
40mm/67° (2" O.D.)	30/2.27°	30/2.23°	50/1.34°
Ultra Wide Angle Eyepieces (8-elements; 1.25" O.D., except as noted)			
4.7mm/84°	251/0.33°	255/0.33°	426/0.20°
6.7mm/84°	176/0.48°	179/0.47°	299/0.28°
8.8mm/84° (1.25" - 2" O.D.)	134/0.63°	136/0.62°	227/0.37°
14mm/84° (1.25" - 2" O.D.)	84/1.00°	86/0.98°	143/0.59°



Fig. 28: Series 4000 Photo-Visual



Fig. 29: Series 4000 Nebular Filters.

Series 4000 8 - 24mm Zoom Eyepiece: The internal zoom optics of this eyepiece move on smooth, precisely machined surfaces which maintain optical collimation at all zoom settings. A scale graduated in 1mm units indicates the zoom focal length in operation. An excellent addition to any eyepiece set.

#140 2x Barlow Lens: A 3-element design, doubles each eyepiece power while maintaining uncompromised image resolution, color correction, and contrast. Insert the #140 into the telescope's eyepiece holder first, followed by the diagonal (as applicable) and eyepiece. The **#126 2x Barlow Lens**, a compact 2-element alternative to the #140, may also be employed with any LXD75-Series telescope.

#905 Variable Polarizer (1.25"): The #905 system includes 2 Polarizer filters mounted in a specially-machined cell, for glare-reduction in observing the Moon. Rotate the thumbscrew at the side of the unit to achieve light transmission between 5% and 25% of its original value. The #905 inserts into the diagonal of the telescope, followed by an eyepiece.

Series 4000 Photo-Visual Color Filters: Color filters significantly enhance visual and photographic image contrast of the Moon and planets. Each filter threads into the barrel of any Meade 1.25" eyepiece, and into the barrels of virtually all other eyepiece brands as well. Meade filters are available in 12 colors for lunar and planetary applications, and in Neutral Density as a lunar glare-reduction filter.

Series 4000 Nebular Filters: A modern boon to the city-dwelling deep-space observer, the interference nebulal filter effectively cancels out the effects of most urban light pollution, while leaving the light of deep-space nebulal emissions virtually unattenuated. Meade Series 4000 Nebular Filters utilize the very latest in coating technology, and are available with threaded cells for eyepieces or for attachment to the rear cells of Meade Schmidt-Cassegrain models.

#928 45° Erect-Image Diagonal Prism: Primarily used for terrestrial viewing, this prism presents a correctly-oriented image at a comfortable 45° viewing angle.

#547 Power Adapter with Cable: Includes a 25 ft. cord and permits powering from a standard home (115v AC) outlet. The **#547F Power Adapter** is available for 220v AC outlets.

#607 Cigarette Lighter Adapter: Power a LXD75-Series telescope by means of an automobile cigarette lighter plug. The LXD75 telescope may be powered for a full night's observing without risk of car-battery drain.

#62 T-Adapter: The T-Adapter is the basic means of prime-focus photography through all Meade Schmidt-Cassegrain models. Thread the T-Adapter on to the rear cell of your telescope, followed by a T-Mount for your 35mm camera, and the camera body is rigidly coupled to the telescope.

Piggyback Brackets: Piggyback photography is one of the most popular and easiest ways to get started in astrophotography. Attach your 35mm camera, with its own 35mm-to-250mm lens, atop your LXD75 in equatorial mode, and guiding the camera through the main telescope, wide-field photos of the Milky Way of remarkable detail and clarity can be taken.

Dew Shield: In moist climates, water particles suspended in the atmosphere may condense on the front surface of the telescope's correcting plate. This dew formation may be inhibited to a significant extent by the addition of a dew shield, essentially an extension tube attaching to the front-cell of the telescope. **#608** for Meade Schmidt-Cassegrain SC-8 model.

#905 Variable Polarizer (1.25"): **#1A Skylight Filter:** The #905 system includes 2 Polarizer filters mounted in a specially-machined cell, for glare-reduction in observing the Moon. Rotate the thumbscrew at the side of the unit to achieve light transmission between 5% and 25% of its original value. The #905 inserts into the diago-



Fig. 30: Optional Autostar handbox for EC model users.

nal of the telescope, followed by an eyepiece. The #1A Skylight Filter threads onto the rear cell of the Meade Schmidt-Cassegrain SC-8 model and effectively seals the interior of the telescope from dust. All other rear cell accessories may then be threaded to the #1A filter. The filter increases visual and photographic contrast, decreases glare, and helps to penetrate haze.

#1205 Electric focuser: For use with LXD75 Schmidt-Cassegrain SC-8 model. Meade electric focusers are uniquely designed to yield smooth, precise microfocusing of the image, without disabling the manual focus knob, which may be used for rapid coarse focusing. Includes push-button hand controller with self-contained (user provided) battery.

#1209 Microfocuser: For use with LXD75 Schmidt-Cassegrain SC-8 model. Supplied with a handbox, the microfocuser threads directly to the rear cell of model SC-8. Permits precise focusing of the image during visual or photographic application, during CCD applications maintains precise image centration on even the smallest CCD chips. Operates at four speeds, from extremely slow to fast; accepts both 2" and 1.25" eyepiece barrels. Requires 8 x AAA (user-supplied batteries).

Series 4000 Plössl 9mm Illuminated Reticle Eyepiece: The most advanced commercially-available illuminated reticle eyepiece, this Series 4000 Plössl 9mm model, powered by an internal battery, includes micrometric x-y positioning controls which greatly facilitate locking onto the guide star: Turn the finely-threaded controls and place the reticle's crossline pattern precisely at the desired position in the field. The sharp, high-power imaging of the 4-element, multi-coated Plössl optical system is complemented by a rubber eyecup (foldable for eyeglass wearers) that shuts out distracting stray light from the observer's eye. The upper (lens) section of the eyepiece rotates on a fine thread for precise diopter adjustment to the user's eye. Reticle pattern is a double crossline with two concentric circles.

Optional #497 Autostar™ Computer Controller for LXD75 EC Users: One of the most important advances in telescope control in the past 25 years, the Meade Autostar Computer Controller turns your LXD75 EC model into an automatic celestial object locating system. Just plug Autostar into the telescope's HBX port in place of the standard-equipment Electronic Controller, do a quick telescope alignment, and you are ready to observe any object in the Autostar's 30,000-object database.

Any of Autostar's database objects can be called up and entered on the hand controller display in seconds. The observer then simply presses the GO TO pushbutton and watches as the telescope automatically slews to the object and places it in the field of view. Autostar moves the telescope to automatically track (follow) the object across the sky. Autostar brings into easy access objects that were previously unreachable for all but the most dedicated of amateur astronomers.

Autostar Suite with Meade LPI (Lunar Planetary Imager) and Planetarium software (Fig. 23) turns your Meade LXD75 telescope, Autostar and PC into even more powerful and easy-to-use astronomical instruments. See page 36 for more details.

To find out more about these and other accessories available for your telescope, check out the Meade General Catalog or contact your local Meade dealer.

Note: It is not necessary for the user to collimate the refractor models.

SC-8 Schmidt-Cassegrain users see ALIGNMENT OF THE SCHMIDT-CASSEGRAIN OPTICAL SYSTEM, page 42.

Newtonian Reflector users see ALIGNMENT OF THE NEWTONIAN REFLECTOR OPTICAL SYSTEM, page 44.

MAINTENANCE

General Maintenance

LXD75-Series telescopes are precision optical instruments designed to yield a lifetime of rewarding applications. Given the care and respect due any precision instrument, your LXD75 will rarely, if ever, require factory servicing. Maintenance guidelines include:

- Avoid cleaning the telescope's optics: A little dust on the front surface of the telescope's correcting lens causes virtually no degradation of image quality and should not be considered reason to clean the lens.
- When absolutely necessary, dust on the front lens should be removed with gentle strokes of a camel hair brush or blown off with an ear syringe (available at any pharmacy). DO NOT use a commercial photographic lens cleaner.
- Organic materials (e.g., fingerprints) on the front lens may be removed with a solution of 3 parts distilled water to 1 part isopropyl alcohol. You may also add 1 drop of biodegradable dishwashing soap per pint of solution. Use soft, white facial tissues and make short, gentle strokes. Change tissues often.

Caution: Do not use scented or lotioned tissues or damage could result to the optics.

- Do not, for any reason, remove the correcting plate from its machined housing for cleaning or other purposes. You will almost certainly not be able to replace the corrector in its proper rotational orientation and serious degradation of optical performance will result. Meade Instruments assumes no liability for damage incurred to the telescope in this way.
- If the LXD75 is used outdoors on a humid night, water condensation on the telescope surfaces will probably result. While such condensation does not normally cause any damage to the telescope, it is recommended that the entire telescope be wiped down with a dry cloth before the telescope is packed away. Do not, however, wipe any of the optical surfaces. Rather, simply allow the telescope to sit for some time in the warm indoor air, so that the wet optical surfaces can dry unattended.
- If your LXD75 is not to be used for an extended period, perhaps for one month or more, it is advisable to remove the batteries from the telescope. Batteries left in the telescope for prolonged periods may leak, causing damage to the telescope's electronic circuitry.
- Do not leave your LXD75 inside a sealed car on a warm summer day; excessive ambient temperatures can damage the telescope's internal lubrication and electronic circuitry.

Alignment (Collimation) of the Schmidt-Newtonian Optical System

All Meade Schmidt-Newtonian telescopes are precisely collimated at the factory before packing and shipment, and it is probable that you will not need to make any optical adjustments before making observations. However, if the telescope sustained rough handling in shipment, you may need to re-collimate the optical system. Such re-collimation is not a difficult procedure in any case.

The collimation procedure for the Meade Schmidt-Newtonians is slightly different from that of other Newtonian reflecting telescopes, because of the "fast" f/4 to f/5 focal ratio of the primary mirror. In typical Newtonian reflectors with more conventional focal ratios (i.e. longer focal ratios), when the observer looks down the focuser tube (with-out an eyepiece in the focuser), the images of the diagonal mirror, primary mirror, focuser tube, and the observer's eye appear centered relative to each other. However, with the short focal ratio primary mirror of the Schmidt-Newtonian, correct collimation requires that the diagonal mirror be offset in 2 directions: (1) away from the focuser and (2) towards the primary mirror, in equal amounts. This offset is approximately 1/8" in each direction. Note that these offsets have been performed at the factory prior to

Tip:

A useful tool for making collimation easier is to make a hole in the plastic cap that comes with the eyepiece to protect it during shipping. Use a drill to make a 1/8" hole in the center of the cap and place it over the eyepiece holder for use during the collimation procedure.

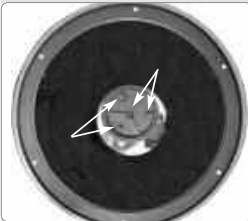

Fig. 31b: The four collimation screws on the diagonal mirror housing.

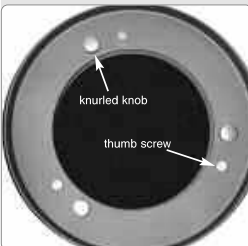

Fig. 31c: The six collimation screws on the rear of the primary mirror cell.

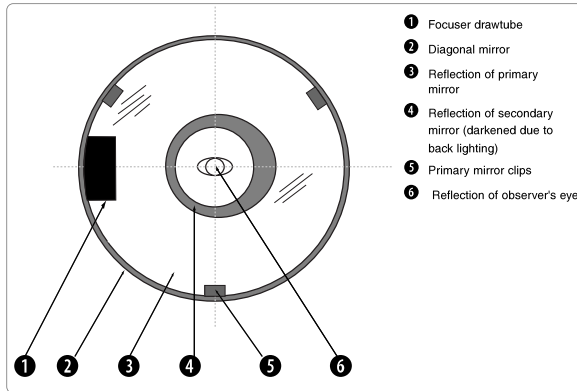

Fig. 31a: The view you will see while collimating a Schmidt-Newtonian telescope.

shipment of your telescope. It is only necessary for you to confirm that the telescope has not been badly jarred out of collimation, and to perform the final fine-tuning of Step 4, below.

Fig. 31a shows a correctly collimated Schmidt-Newtonian telescope, as it appears when viewed through the focuser with the eyepiece removed.

To check and, if necessary, set the optical collimation, follow these steps.

1. Observe through the focuser and orient your body so that the telescope's primary mirror is to your right, and the correcting plate end of the telescope tube is to your left. The diagonal mirror will appear centered as shown (2, Fig. 31a). If the diagonal appears off center, then adjust the 4 collimation screws on the plastic diagonal mirror housing.

2. If the reflection of the primary mirror (3, Fig. 31a) is not centered on the surface of the diagonal mirror, adjust the 4 collimation screws on the plastic diagonal mirror housing to center the reflection.

As described above, the 4 collimation screws (Fig. 31b) on the plastic diagonal mirror housing are used for two different adjustments during the collimation procedure.

Important Note: Do not force the 4 screws past their normal travel, and do not rotate any screw or screws more than 2 full turns in a counter-clockwise direction (i.e., not more than 2 full turns in their "loosening" direction), or else the diagonal mirror may become loosened from its support. Note that the diagonal mirror collimation adjustments are very sensitive: generally turning a collimation screw 1/2-turn will have a dramatic effect on collimation.

3. If the reflection of the diagonal mirror is not centered within the reflection of the primary mirror, adjust the 3 collimation screws located on the rear of the primary mirror cell.

Note: There are 6 screws (Fig. 31c) on the primary mirror cell. The 3 knurled knobs are the collimation screws, and the 3 smaller thumb screws are locking screws. The locking screws must be loosened slightly in order to adjust the collimation screws.

Proceed by "trial and error" until you develop a feel for which collimation screw to turn in order to change the image in any given way.

Note: A small paper ring is attached to the primary mirror. This ring was attached at the factory for purposes of laser collimation. The ring will not diminish your telescope's imaging capabilities and does not need to be removed.

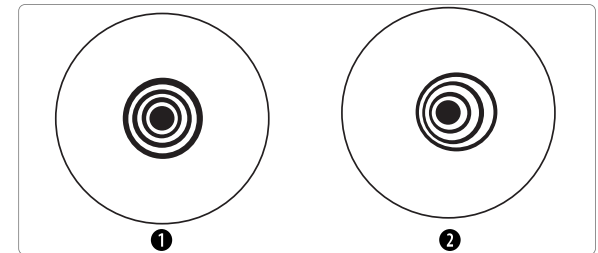

Fig. 32: Correct (1) and incorrect (2) collimation as viewed during a star test.

4. Perform an actual star test to confirm the accuracy of steps 1 through 3. Using the SP 26mm eyepiece, point the telescope at a moderately bright (second or third magnitude) star, and center the image in the main telescope's field of view.

5. Bring the star's image slowly in and out of focus until you see several disks surrounding the star's center. If steps 1 through 3 were done correctly, you will see concentric (centered with respect to each other) circles (1, Fig. 32).

An improperly collimated instrument will reveal oblong or elongated circles (2, Fig. 32). Adjust the 3 collimating screws on the primary mirror housing until the circles are concentric on either side of the focus.

In summary, the 4 adjustment screws on the plastic diagonal mirror housing change the tilt of the secondary mirror so that it is correctly centered in the focuser drawtube, and so that the primary mirror appears centered when looking into the focuser. The 3 collimating knobs on the primary mirror change the tilt of the primary mirror so that it reflects the light directly up the center of the drawtube.

Alignment (Collimation) of the Schmidt-Cassegrain Optical System

The optical collimation (alignment) of any astronomical telescope used for serious purposes is important, but in the case of the Schmidt-Cassegrain design of the model SC-8, such collimation is absolutely essential for good performance. Take special care to read and understand this section well so that your model SC-8 will give you the best optical performance.

As part of final optical testing, every Meade Schmidt-Cassegrain is precisely collimated at the Meade factory before shipment. However, vibrations in shipping can cause the optical system to become misaligned. Re-aligning the optics is, however, a straightforward process.

To check the collimation of your SC-8, center a bright star that is overhead, or use a "hot spot" of reflected sunlight from a chrome car bumper, with the supplied 26mm eyepiece. Allow the telescope to adjust to the temperature of your observation site before proceeding; temperature differences between the optics and the outside air can cause distortion in the images.

With the star or hot spot centered, de-focus the image. You will notice that the out of focus star image looks like a ring of light surrounding a dark central spot; the dark central spot is in fact the shadow of the secondary mirror. Turn the focus knob until the ring of light fills about 10% of the eyepiece field-diameter. If the dark central spot is offset in (i.e., not concentric with) the ring of light, your telescope's optical system is misaligned and requires collimation.

Follow these steps for collimation of the optical system:

- a. The only adjustments possible, or necessary, on the SC-8 models are from the three screws (Fig. 33b) located at the edge of the outer surface of the secondary mirror housing.

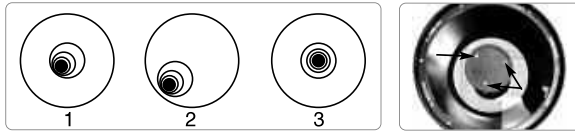

Fig. 33a: Defocused star images. Misaligned (1, 2), Aligned (3)

Fig. 33b: Collimation screws.

Caution: Do not force the three collimation screws past their normal travel and do not loosen them more than two full turns in a counterclockwise direction or the secondary mirror may come loose from its support. You will find that the adjustments are very sensitive, usually requiring only one-half turn or less to produce the desired result.

- b. While looking at the defocused star image, notice which direction the darker shadow is offset in the ring of light or notice which part of the ring is the thinnest (1, Fig. 33a). Place your index finger in front of the telescope so that it touches one of the collimation set screws. You will see the shadow of your finger in the ring of light. Move your finger around the edge of the black plastic secondary mirror support until you see the shadow of the finger crossing the thinnest part of the ring of light. At this point, look at the front of the telescope where your finger is aiming. It will either be pointing directly at a set screw, or it will be between two set screws aiming at the set screw on the far side of the black plastic secondary mirror support. This is the set screw that you will adjust.
- c. Using the Autostar's Arrow keys at the slowest slew speed, move the defocused image to the edge of the eyepiece field of view (2, Fig. 33a), in the same direction as the darker shadow is offset in the ring of light.
- d. Turn the set screw that you found with the pointing exercise while looking in the eyepiece. You will notice that the star image will move across the field. If while turning the defocused star image flies out of the eyepiece field, then you are turning the screw the wrong way. Turn the opposite direction and bring the image back to the center of the field.
- e. If the screw you are turning becomes very loose, tighten the other two screws by even amounts. If the screw you are turning gets too tight, unthread the other two by even amounts.
- f. When you bring the image to center (3, Fig. 33a), carefully examine the evenness of the ring of light (concentricity). If you find that the dark center is still off in the same direction, continue to make the adjustment in the original turning direction. If it is now off in the opposite direction, you have turned too far and you need to turn in the opposite direction. Always double check the image in the center of the field of the eyepiece.
- g. You may find after your initial adjustment that the dark center is off in a new direction (e.g., instead of being off side-to-side it is now off in an up-and-down direction). In this case repeat steps b through f to find the new adjustment screw.
- h. Now try a higher power eyepiece (e.g., 9mm or less) and repeat the above tests. Any lack of collimation at this point will require only very slight adjustments of the three set screws. You now have good collimation of the optics.
- i. As a final check of alignment, examine the star image in focus with the higher power eyepiece as suggested (j), under good viewing conditions. The star point should appear as a small central dot (commonly referred to as an "Airy disc") with a diffraction ring surrounding it. To give a final precision collimation, make extremely slight adjustments of the three set screws, if necessary, to center the Airy disc in the diffraction ring. You now have the best alignment of the optics possible with this telescope.

Alignment (Collimation) of the Newtonian Reflector Optical System

The optical systems of Newtonian Reflector telescopes include the following parts: primary mirror (1, Fig. 34); secondary mirror (2, Fig. 34); secondary mirror-holder (3, Fig. 34); secondary mirror-vanes (4, Fig. 34) and (1, Fig. 35); primary mirror-tilt screws (5, Fig. 34). The telescope's image is brought to a focus at (6, Fig. 34).

1. **Confirm alignment** - To confirm optical alignment look down the focuser drawtube (1, Fig. 37) with the eyepiece removed. The edge of the focuser drawtube frames reflections of the primary mirror (2, Fig. 37), the secondary mirror (3, Fig. 37), the three ("spider") vanes (4, Fig. 37) holding the secondary mirror, and the observer's eye (5, Fig. 37). With the optics properly aligned, all of these reflections appear concentric (centered), as shown in Fig. 37. Any deviation from concentricity of any of these telescope parts with the eye requires adjustments to the secondary mirror-holder (Fig. 35) and/or the primary mirror cell (Fig. 36, as described below).
 2. **Secondary mirror-vane adjustments:** If the secondary mirror (1, Fig. 38) is left or right of center within the drawtube (2, Fig. 38), slightly loosen the 3-vane adjustment/lock knobs (1, Fig. 35) located on the outside surface of the main tube and slide the entire secondary mirror-holder system up or down in the slotted holes of the main tube until the secondary mirror is centered in the drawtube. If the secondary mirror (1, Fig. 38) is above- or below-center within the drawtube, thread inward one of the adjustment/lock knobs (1, Fig. 35) while unthreading another of these knobs. Only make adjustments to two knobs at a time until the secondary mirror appears as in Fig. 39.
 3. **Secondary mirror-holder adjustments:** If the secondary mirror (1, Fig. 39) is centered in the focuser drawtube (2, Fig. 39), but the primary mirror is only partially visible in the reflection (3, Fig. 39), the three "+" (Phillips head) secondary mirror-tilt screws (2, Fig. 35) should be slightly unthreaded to the point where the secondary mirror-holder (3, Fig. 35) can rotate about its axis parallel to the main tube. Grasp the secondary mirror-holder (avoid touching the mirror surface!) with your hand and rotate it until, looking through the drawtube, you can see the primary mirror centered as well as possible in the reflection of the secondary mirror. With the rotation of the secondary mirror-holder at this best-possible position, thread in the three Phillips head screws (2, Fig. 35) to lock the rotational position. Then, if necessary, make adjustments to these three Phillips head screws to refine the tilt-angle of the secondary mirror, until the entire primary mirror can be seen centered within the secondary mirror's reflection. With the secondary mirror thus aligned the image through the drawtube appears as in Fig. 40.
 4. **Primary mirror adjustments:** If the secondary mirror (1, Fig. 40) and the reflection of the primary mirror (2, Fig. 40) appear centered within the drawtube (3, Fig. 40), but the reflection of your eye and the reflection of the secondary mirror (4, Fig. 40) appear off-center, then the primary mirror tilt requires adjusting, using the Phillips head screws of the primary mirror cell (3, Fig. 36). These primary mirror-tilt screws are located behind the primary mirror, at the lower end of the main tube. See Fig. 36. Before adjusting the primary mirror-tilt screws, first unscrew by several turns (use either a hex wrench or pliers) the three hex-head primary mirror lock screws (2, Fig. 36) which are also located on the rear surface of the primary mirror cell and which alternate around the cell's circumference with the three Phillips head screws. Then by trial and error turn the primary mirror Phillips head tilt screws (3, Fig. 36) until you develop a feel for which way to turn each screw to center the reflection of your eye in the drawtube. (An assistant is helpful in this operation.) With your eye centered as shown in Fig. 37, turn the three hex head primary mirror lock screws (2, Fig. 36) to re-lock the tilt-angle of the primary mirror.

The telescope's optical system is now aligned, or collimated. (This collimation should be re-checked from time to time, with small adjustments (per steps 1, 2, and/or 3, above) effected as required to keep the optics well-aligned.

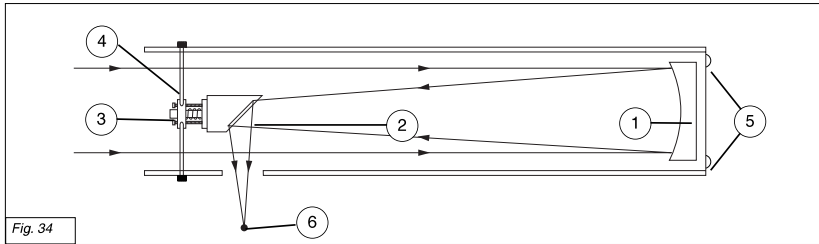

Fig. 34

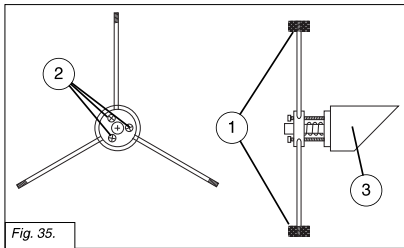

Fig. 35

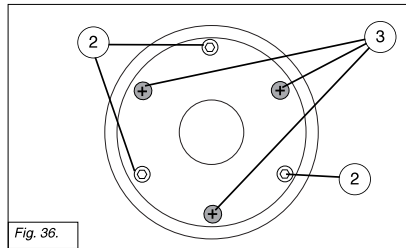

Fig. 36

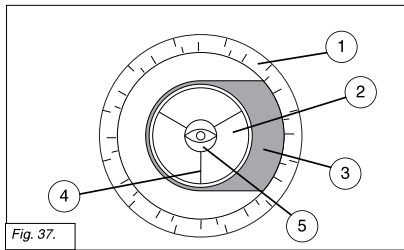

Fig. 37

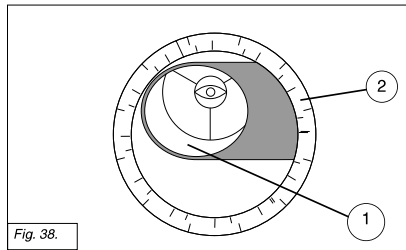

Fig. 38

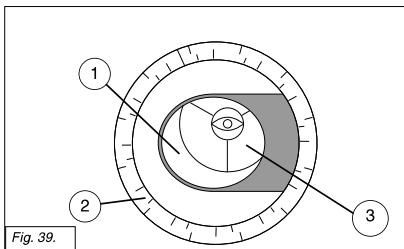

Fig. 39

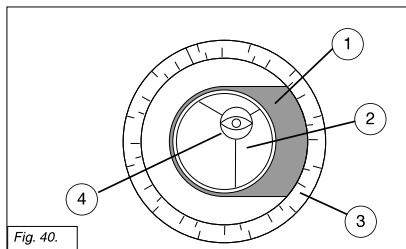

Fig. 40

SPECIFICATIONS

6" f/5 Model SN-6AT, SN-6EC Specifications

Optical design	Schmidt-Newtonian
Clear aperture	6" (152mm)
Focal length	762mm
Focal ratio (photographic speed)	f/5
Resolving power	0.74 arc secs
Coatings	Meade EMC Super Multi-Coatings Ultra-High Transmission Coating optional
Mounting	Die-cast aluminum
Input Voltage	12v DC
Alignment	German-type equatorial mount
Slew Speeds	SN-8: 1x sidereal to 4.5°/sec in 9 increments SN-8EC: 2x sidereal to 4.5°/sec in 4 increments
Tripod	Variable-height field tripod
Accessories	8 x 50mm finder T-Adapter Super Plössl 26mm eyepiece 1.25" and 2" eyepiece holders Battery pack for 8 D-cell batteries (user-supplied) SN-6: Autostar Controller SN-6EC: Electronic Controller
Polar Finder Reticle Batteries	Maxell LR41 or equivalent
Net telescope weight	13 lbs.
Net tripod weight	35 lbs.

8" f/4 Model SN-8AT, SN-8EC Specifications

Optical design	Schmidt-Newtonian
Clear aperture	8" (203mm)
Focal length	812mm
Focal ratio (photographic speed)	f/4
Resolving power	0.56 arc secs
Coatings	Meade EMC Super Multi-Coatings Ultra-High Transmission Coating optional
Mounting	Die-cast aluminum
Input Voltage	12v DC
Alignment	German-type equatorial mount
Slew Speeds	SN-8: 1x sidereal to 4.5°/sec in 9 increments SN-8EC: 2x sidereal to 4.5°/sec in 4 increments
Tripod	Variable-height field tripod
Accessories	8 x 50mm finder T-Adapter Super Plössl 26mm eyepiece 1.25" and 2" eyepiece holders Battery pack for 8 D-cell batteries (user-supplied) SN-8: Autostar Controller SN-8EC: Electronic Controller
Polar Finder Reticle Batteries	Maxell LR41 or equivalent
Net telescope weight	24 lbs.
Net tripod weight	45 lbs.

10" f/4 Model SN-10AT Specifications

Optical design	Schmidt-Newtonian
Clear aperture	10" (254mm)
Focal length	1016mm
Focal ratio (photographic speed)	f/4
Resolving power	0.45 arc secs
Coatings	Meade EMC Super Multi-Coatings Ultra-High Transmission Coating optional
Mounting	Die-cast aluminum
Input Voltage	12v DC
Alignment	German-type equatorial mount
Slew Speeds	1x sidereal to 4.5°/sec in 9 increments
Tripod	Variable-height field tripod
Accessories	8 x 50mm finder T-Adapter Super Plössl 26mm eyepiece 1.25" and 2" eyepiece holders Battery pack for 8 D-cell batteries (user-supplied) Autostar Controller
Polar Finder Reticle Batteries	Maxell LR41 or equivalent
Net telescope weight	30 lbs.
Net tripod weight	55 lbs.

5" f/9.3 Model AR-5AT, AR-5EC Specifications

Optical design	Achromatic Refractor
Clear aperture	5" (127mm)
Focal length	1180mm
Focal ratio (photographic speed)	f/9.3
Resolving power	0.90 arc secs
Coatings	Meade EMC Super Multi-Coatings
Mounting	Die-cast aluminum
Input Voltage	12v DC
Alignment	German-type equatorial mount
Slew Speeds	SN-8: 1x sidereal to 4.5°/sec in 9 increments SN-8EC: 2x sidereal to 4.5°/sec in 4 increments
Tripod	Variable-height field tripod
Accessories	8 x 50mm finder 1.25" diagonal Super Plössl 26mm eyepiece 1.25" and 2" eyepiece holders Battery pack for 8 D-cell batteries (user-supplied) AR-5: Autostar Controller AR-5EC: Electronic Controller
Polar Finder Reticle Batteries	Maxell LR41 or equivalent
Net telescope weight	15 lbs.
Net tripod weight	35 lbs.

6" f/8 Model AR-6AT Specifications

Optical design	Achromatic Refractor
Clear aperture	6" (152mm)
Focal length	1200mm
Focal ratio (photographic speed)	f/8
Resolving power	0.74 arc secs
Coatings	Meade EMC Super Multi-Coatings
Mounting	Die-cast aluminum
Input Voltage	12v DC

Alignment	German-type equatorial mount
Slew Speeds	1x sidereal to 4.5°/sec in 9 increments
Tripod	Variable-height field tripod
Accessories	8 x 50mm finder 1.25" diagonal Super Plössl 26mm eyepiece 1.25" and 2" eyepiece holders Battery pack for 8 D-cell batteries (user-supplied) Autostar Controller
Polar Finder Reticle Batteries	Maxell LR41 or equivalent
Net telescope weight	27 lbs.
Net tripod weight	45 lbs.

8" f/10 Model SC-8AT Specifications

Optical design	Schmidt-Cassegrain
Clear aperture	8" (203mm)
Focal length	2000mm
Focal ratio (photographic speed)	f/10
Resolving power	0.56 arc secs
Coatings	Meade EMC Super Multi-Coatings Ultra-High Transmission Coating optional
Mounting	Die-cast aluminum
Input Voltage	12v DC
Alignment	German-type equatorial mount
Slew Speeds	1x sidereal to 4.5°/sec in 9 increments
Tripod	Variable-height field tripod
Accessories	8 x 50mm finder 1.25" diagonal Super Plössl 26mm eyepiece 1.25" and 2" eyepiece holders Battery pack for 8 D-cell batteries (user-supplied) Autostar Controller
Polar Finder Reticle Batteries	Maxell LR41 or equivalent
Net telescope weight	24 lbs.
Net tripod weight	45 lbs.

6" f/5 Model N-6EC Specifications

Optical design	Newtonian Reflector
Clear aperture	6" (152mm)
Focal length	762mm
Focal ratio (photographic speed)	f/5
Resolving power	0.74 arc secs
Coatings	Meade EMC Super Multi-Coatings Ultra-High Transmission Coating optional
Mounting	Die-cast aluminum
Input Voltage	12v DC
Alignment	German-type equatorial mount
Slew Speeds	1x sidereal to 4.5°/sec in 9 increments
Tripod	Variable-height field tripod
Accessories	6 x 30mm finder 1.25" diagonal Super Plössl 26mm eyepiece 1.25" and 2" eyepiece holders Battery pack for 8 D-cell batteries (user-supplied) Autostar Controller
Polar Finder Reticle Batteries	Maxell LR41 or equivalent
Net telescope weight	26 lbs.
Net tripod weight	45 lbs.

Autostar Specifications

Processor	68HC11, 8MHz
Flash Memory	1.0MB, reloadable
Keypad	20 key alphanumeric
Display	2 line, 16 character LCD
Backlight.....	Red LED
Utility Light	Yes
Coil Cord	24"
Database	30,223 objects

Autostar Dimensions

Length	6.56" (16.6cm)
Width (LCD end)	3.19" (80cm)
Width (Connector end).....	2.25" (57cm)
Depth	0.81" (21cm)
Autostar net weight	1.12 lbs (0.51kg)

Maxell is a trademark of Hitachi Maxell, Ltd.

Inspecting the Optics

A Note About the Flashlight Test: If a flashlight or other high-intensity light source is pointed down the main telescope tube, the view (depending upon the observer's line of sight and the angle of the light) may reveal what appears to be scratches, dark or bright spots, or just generally uneven coatings, giving the appearance of poor quality optics. These items are only seen when a high intensity light is transmitted through lenses or reflected off the mirrors, and can be seen on any high quality optical system, including giant research telescopes.

The optical quality of a telescope cannot be judged by the "flashlight test;" the true test of optical quality can only be conducted through careful star testing.

Meade Customer Service

If you have a question concerning your LX75-Series telescope, contact the Meade Instruments Customer Service Department at:

Telephone: (949) 451-1450

Customer Service hours are 7:00 AM to 6:00 PM, Pacific Time, Monday through Friday. In the unlikely event that your LX75-Series telescope requires factory servicing or repairs, write or call the Meade Customer Service Department first, before returning the telescope to the factory, giving full particulars as to the nature of the problem, as well as your name, address, and daytime telephone number. The great majority of servicing issues can be resolved by telephone, avoiding return of the telescope to the factory. If factory service is required, you will be assigned a Return Goods Authorization (RGA) number prior to return.

APPENDIX A: CELESTIAL COORDINATES

A celestial coordinate system was created that maps an imaginary sphere surrounding the Earth upon which all stars appear to be placed. This mapping system is similar to the system of latitude and longitude on Earth surface maps.

In mapping the surface of the Earth, lines of longitude are drawn between the North and South Poles and lines of latitude are drawn in an East-West direction, parallel to the Earth's equator. Similarly, imaginary lines have been drawn to form a latitude and longitude grid for the celestial sphere. These lines are known as **Right Ascension** and **Declination**.

The celestial map also contains two poles and an equator just like a map of the Earth. The poles of this coordinate system are defined as those two points where the Earth's north and south poles (*i.e.*, the Earth's axis), if extended to infinity, would cross the celestial sphere. Thus, the North Celestial Pole (1, Fig. 41) is that point in the sky where an extension of the North Pole intersects the celestial sphere. The North Star, Polaris is located very near the North Celestial Pole. The celestial equator (2, Fig. 41) is a projection of the Earth's equator onto the celestial sphere.

Just as an object's position on the Earth's surface can be located by its latitude and longitude, celestial objects may also be located using Right Ascension and Declination. For example, you could locate Los Angeles, California, by its latitude (+34°) and longitude (118°). Similarly, you could locate the Ring Nebula (M57) by its Right Ascension (18hr) and its Declination (+33°).

■ **Right Ascension (R.A.):** This celestial version of longitude is measured in units of hours (hr), minutes (min), and seconds (sec) on a 24-hour "clock" (similar to how Earth's time zones are determined by longitude lines). The "zero" line was arbitrarily chosen to pass through the constellation Pegasus — a sort of cosmic Greenwich meridian. R.A. coordinates range from 0hr 0min 0sec to 23hr 59min 59sec. There are 24 primary lines of R.A., located at 15-degree intervals along the celestial equator. Objects located further and further East of the zero R.A. grid line (0hr 0min 0sec) carry higher R.A. coordinates.

■ **Declination (Dec.):** This celestial version of latitude is measured in degrees, arc-minutes, and arc-seconds (*e.g.*, 15° 27' 33"). Dec. locations north of the celestial equator are indicated with a plus (+) sign (*e.g.*, the Dec. of the North celestial pole is +90°). Dec. locations south of the celestial equator are indicated with a minus (-) sign (*e.g.*, the Dec. of the South celestial pole is -90°). Any point on the celestial equator (such as the constellations of Orion, Virgo, and Aquarius) is said to have a Declination of zero, shown as 0° 0' 0."

Setting Circles

Setting circles included with the LX75-Series models permit the location of faint celestial objects not easily found by direct visual observation. With the telescope pointed at the North Celestial Pole, the Dec. circle (19, Fig. 1d) should read 90° (understood to mean +90°). Each division of the Dec. circle represents a 1° increment. The R.A. circle (31, Fig. 1d) runs from 0° to (but not including) 24°, and reads in increments of 5^m.

Using setting circles requires a developed technique. When using the circles for the first time, try hopping from one bright star (the calibration star) to another bright star of known coordinates. Practice moving the telescope from one easy-to-find object to another. In this way, the precision required for accurate object location becomes evident.

Note You may also enter an object's R.A. and Dec. coordinates using the "User: Objects" option of Autostar's Object menu. Autostar then automatically slews the telescope to the entered coordinates.

To use the setting circles to locate an object not easily found by direct visual observation:

Insert a low-power eyepiece, such as a 26mm, into the focuser assembly. Pick out a bright star with which you are familiar (or is easily located) that is in the area of the sky in which your target object is located. Look up the R.A. coordinate of the bright star,

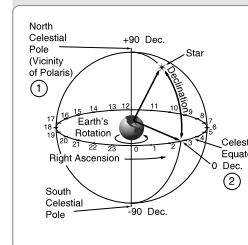

Fig. 41: Celestial Sphere.

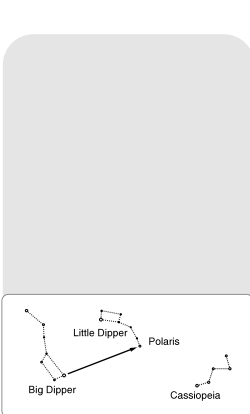

Fig. 42 Locating Polaris.

and also of the object you wish to locate, in a star atlas. Point the object at the bright star. Then loosen the R.A. setting circle lock knob (32, Fig. 1d) and turn the R.A. setting circle to read the correct R.A. coordinate of the bright star; lock the R.A. setting circle lock knob onto the object. Next, loosen the R.A. lock (33, Fig. 1d) and turn the telescope in R.A. to read the correct R.A. coordinate of the object. Tighten the R.A. lock (33, Fig. 1d). If the procedure has been followed carefully, the desired object should now be in the telescopic field of a low-power eyepiece.

If you do not immediately see the object you are seeking, try searching the adjacent sky area. Keep in mind that, with the 26mm eyepiece, the field of view of the LX75-Series is about 0.5°. Because of its much wider field, the viewfinder may be of significant assistance in locating and centering objects, after the setting circles have been used to locate the approximate position of the object.

See USING AUTOSTAR TO FIND OBJECTS NOT IN THE LIBRARIES, page 33, for information on how to manually enter coordinates into Autostar.

Locating the Celestial Pole

To get basic bearings at an observing location, take note of where the Sun rises (East) and sets (West) each day. After the site is dark, face North by pointing your left shoulder toward where the Sun set. To precisely point at the pole, find the North Star (Polaris) by using the Big Dipper as a guide (Fig. 42).

Polar Alignment

Autostar provides several different methods of Polar Alignment: Easy, One-Star, Two-Star and Three-Star. See EASY ALIGNMENT, page 21, and THREE-STAR ALIGNMENT USING AUTOSTAR, page 52, for those procedure.

One-Star Polar Alignment

Polar One-Star Alignment requires some knowledge of the night sky. Autostar provides a library of bright stars and one star from this library is chosen by the observer for alignment. Polaris is chosen by Autostar. The rest of the procedure is almost identical to the EASY ALIGNMENT, page 21, except that Autostar prompts you to point the telescope at Polaris and center it in the telescope's eyepiece.

Two-Star Polar Alignment

Polar Two-Star Alignment requires some knowledge of the night sky. Autostar provides a library of bright stars and two stars from this library are chosen by the observer for alignment. Polaris is chosen by Autostar. The rest of the procedure is almost identical to the EASY ALIGNMENT, page 21, except that Autostar prompts you to point the telescope at Polaris and center it in the telescope's eyepiece.

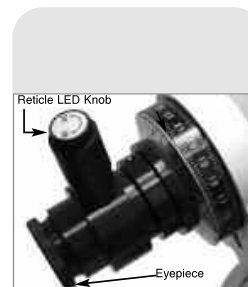

Fig. 43a: The polar alignment viewfinder.

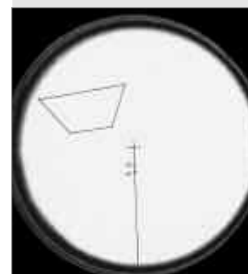

Fig. 43b: The view inside the polar alignment viewfinder reticle.

APPENDIX B: ENHANCING POINTING PRECISION

The Polar Alignment Viewfinder

Typically Autostar's pointing capabilities are sufficient for most telescope observers, and the use of the polar alignment viewfinder is unnecessary for them. However, for those observers who need to meet the more demanding requirements of astrophotography, the polar alignment viewfinder allows the telescope mount to be more precisely aligned with true North. The polar alignment viewfinder contains a reticle, lit by an LED (Figs. 43a and 43b).

To align your telescope to North using the polar alignment viewfinder:

1. Set your telescope in the home position (see page 17). Then loosen the Dec. lock (17, Fig. 1d) and rotate the optical tube 90°. Re-tighten the Dec. Lock.
2. Loosen the R.A. Lock (33, Fig. 1d).
3. Remove the polar viewfinder cap (18, Fig. 1d).
4. If you have not already done so, remove the plastic separating the watch batteries inside the polar alignment reticle. See step 12, page 13.
5. Turn the polar alignment reticle LED knob to turn on the LED and look through the reticle.
6. **Northern Hemisphere:** Move the telescope mount until Polaris is superimposed on the graduated area of the reticle (between 40' and 60'). The center crosshair denotes the North celestial pole. **Southern Hemisphere:** The four-sided figure in the reticle represents a grouping of four stars in Octantis (Sigma, Tau, Chi, and Upsilon) for use in the Southern Hemisphere. Move the telescope mount on its R.A. axis until the four stars depicted in the reticle are superimposed on the four star group that matches the reticle pattern.
7. Use the latitude T-handle screws (26, Fig. 1d) and the fine azimuth control knobs (27, Fig. 1d) to fine tune the mount adjustment until the reticle pattern is more precisely superimposed over the appropriate position as described in step 6.

Note: Not all pointing positions are possible with the polar alignment reticle, as the tripod is a limiting factor as to how far the optical tube and mount can be moved.
8. Tighten the R.A. Lock (33, Fig. 1d). Return the optical tube to the home position.

Note: Remember to turn off the polar alignment reticle LED.

Enhancement Methods

Autostar provides four methods of enhancing your telescope's pointing precision:

#1: Three-Star Alignment, #2: Axis Alignment #3: Axis Alignment with Autostar and #4: Smart Drive Training (Periodic Error Correction).

Method #1 is recommended for all users, but especially for the beginner and Methods #2, #3 and #4 are recommended for the Advanced observer.

Method #1: Three-Star Alignment Using Autostar

Perform this procedure at night. This method is similar to Two-Star Alignment (see page 51), but in this method, Autostar chooses three stars to align upon: Two stars on one side of the sky and a third star on the opposite side of the sky.

In order to get the most out of this procedure, make sure you perform the Train the Drive procedure (see page 20). The combination of Training your Drive and performing Three-Star Alignment will optimize your pointing accuracy.

To perform the Three-Star Alignment:

1. Keep pressing MODE until "Select Item: Setup" is displayed. Press ENTER.
2. "Setup: Align" displays. Press ENTER. "Align: Easy" displays. Press the Scroll Down key until "Align: Three-Star" displays. Press ENTER.
3. "German North" displays and a scrolling message prompts you to set your telescope in the polar home position. See SETTING THE POLAR HOME POSITION, page 17, for a description of this procedure. Press ENTER after you finish the procedure.

- Autostar then chooses three stars from its database to align upon. When the telescope slews to a star for alignment, it may not appear in the field of view in the eyepiece. Use the Arrow keys to move the telescope until the star is visible and centered in the eyepiece. The alignment star should be easily recognized and be the brightest star in the area of the sky where the telescope is pointing. See **WHICH ONE'S THE ALIGNMENT STAR**, page 18, for more information. When the star is centered, press ENTER. Repeat the procedure for the second and third alignment stars.

Note: Autostar locates alignment stars based on the date, time, and location entered. The alignment stars may change from night to night. All that is required is for the observer to center the selected star in the eyepiece when prompted.

Method 2: Axis Alignment Procedures

In order for the equatorial mount to accurately point to astronomical objects using the GO TO feature of the Autostar handbox, the optical axis of the optical tube must be aligned with the R.A. axis of the mount. In most cases, the telescope will perform adequately without making any adjustments, but performing one of the following alignment methods before the initial use of the telescope, and periodically thereafter, will increase the mount's pointing accuracy.

When the optical axis is perfectly aligned to the R.A. axis and the declination set to 90°, all objects will rotate about a point in the center of the eyepiece, as the mount is rotated about the R.A. axis. A misalignment in elevation results in the center of rotation shifting up or down. A misalignment in attitude results in the center shifting left or right.

The telescope is moved manually in Method #1 to correct for attitude misalignment and then for elevation misalignment. Autostar moves the telescope in Method #2.

Procedure #1: To correct for attitude misalignment

Important Note: Throughout the following procedures, the directional references up/down/left/right are used. No matter which type of telescope model you are using, these directions are to be interpreted relative to real-world targets. For example, left/right moves the image along the horizon, and up/down moves the image vertically.

Perform this procedure during the daytime. You will need to have a clear line of sight to a wide, distinct landmark with a clear, horizontal feature.

- Plug in Autostar and turn on the power as described previously in this manual. You will use Autostar's Arrow keys in the course of this procedure.
- Loosen the R.A. Lock (33, Fig. 1d) and the Dec. Lock (17, Fig. 1d). Point the tube so that the tripod leg below the Fine Azimuth Control Knobs (27, Fig. 1c) approximately faces North (or South in the Southern Hemisphere). Retighten the Dec. Lock. Move the counterweight shaft and mount so that it is parallel to the horizon. This is position A. See Fig. 45. Retighten the R.A. Lock.
- If using a Schmidt Newtonian model, rotate the optical tube (you will need to loosen the cradle ring lock knobs (13, Fig. 1a) to do so) to make sure the focuser extends horizontally from the optical tube while in position A and do not rotate the tube for the remainder of the alignment procedure.

If using a refractor model, use the diagonal assembly to rotate the eyepiece during testing. However, be careful that the diagonal is placed flush against the focuser and tightened in place using the thumbscrews. It is important that the diagonal does not slip during the procedure.

- Adjust the tripod legs, polar axis altitude and/or polar axis azimuth so that the wide, horizontal object you have chosen as a target is positioned across the middle of the eyepiece.



Procedure #1: Step 4

Step 5

Step 6

Step 7

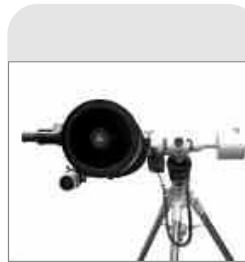

Fig. 45: Position A.



Fig. 46: Position B.



Fig. 47: Cradle adjustment screws.

Important Note: The image will appear right-side-up, but reversed left-for-right, in the eyepiece of a refractor telescope. The image will appear upside-down, but correct left-for-right, in the eyepiece of a Schmidt-Newtonian telescope, if the eyepiece extends horizontally from the tube, as described in Step #3.

- Loosen the R.A. Lock (Tip: Make sure you do not accidentally loosen the Dec. Lock. If you do, restart the procedure beginning at Step #2). Rotate the telescope 180° in the R.A. axis ONLY, until the optical tube is in position B. See Fig. 46. Note the position of your target in the eyepiece.
- Using the Autostar Up and Down Arrow keys ONLY, move the optical tube in Dec. axis until your target is HALFWAY back to the center of the eyepiece.
- Rotate the telescope 180° in the R.A. axis ONLY, to return the optical tube to position A. Verify that your target is in the same location in the eyepiece vertically as in the previous step (that is, it is not higher or lower or absent from the eyepiece). Ignore side-to-side misalignment (that is, if it has moved to the right or left).
- Repeat steps 6 and 7, if necessary, alternating positions A and B, until the horizontal object is in the same vertical location in the eyepiece in both positions.
- The Dec. optical axis is now calibrated to be at 90 degrees. For Procedure #2, DO NOT adjust the declination of the optical tube, either manually or with the handbox.

Procedure #2: To correct for elevation misalignment

After performing the attitude correction, select an object that is at a very great distance (at least a mile away) to approximate infinity. Ideally, the object should be unique, with several identifiable objects to the left and right of it.

- Rotate the mount about the R.A. axis only and move the optical tube to position A.
- WITHOUT moving the declination axis from its position determined in the previous alignment, adjust the legs, latitude, and azimuth of the tripod to center the object in the eyepiece.



Procedure #2: Step 2

Step 4

Step 5

Step 6

- Rotate the telescope 180° in the R.A. axis ONLY, until optical tube is in position B.
- Observe the position of the object in the eyepiece. Assuming that the declination was properly set in the previous procedure, the object should have moved only horizontally (that is, side-to-side) from its original position. It may be out of the eyepiece altogether.
- Using the adjustment mechanism on the bottom of the cradle (Fig. 47), move the reference object approximately half the distance towards the center of the eyepiece.

To adjust the cradle screws, use the supplied hex key to loosen the two outside screws. Then adjust the position of the object by tightening or loosening the center screw. Perform this adjustment on both sets of screws. When finished, retighten the outer screws.

Before moving the optical tube, note the location that the telescope is centered on relative to the reference object. Depending on the telescope type and accessories in use, you may need to move the optical tube opposite to the direction that appears in the eyepiece. The best way to be sure is to move the optical tube (using the cradle screws) a little, and verify that the correct direction was moved through the eyepiece.

- WITHOUT moving the declination axis from its position determined in the previous alignment, and WITHOUT adjusting the cradle position further, adjust the legs, latitude, and azimuth of the tripod to center the object in the eyepiece again.

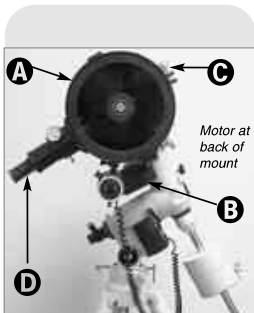

Fig. 48: Method #2 Setup. (A) Optical Tube; (B) Dec. Motor; (C) Cradle Ring Lock Knobs; (D) Eyepiece.

- Rotate the telescope 180° in the R.A. axis ONLY, to return the optical tube to position A.
- Repeat steps 5 through 8, if necessary, alternating between position A and position B, and bringing the reference object halfway of the remaining distance to center. Stop the procedure once the distance between the object in position A and position B is less than one third the width of the eyepiece.
- As a final check, select another object and place it into the center of the eyepiece. Rotate the mount about the R.A. axis. Watch the motion of that object. It is acceptable if it moves slightly, but should remain in the eyepiece the entire time.

Tips

- When moving to position A or B, it is usually sufficient to merely level the Dec. axis by eye. Whether in position A or B, the counterweight shaft should appear to be horizontal when looked at from several feet away.
- If you are finding it difficult to lower the altitude of the tripod head without the counterweight banging into the forward tripod leg, increase the length of the two rear tripod legs to introduce a tilt into the whole mount.
- Before starting the alignment procedure, it is helpful to have the tripod azimuth adjustment knobs even, to allow an equal range of travel in either direction.
- Make sure the focuser lock is tightened once focus is achieved. Otherwise, gravity may cause the focuser to move during rotation of the telescope and introduce error into the procedure.

Method 3: Axis Alignment Using Autostar

Perform this procedure during the daytime. You will need to have an unobstructed view of an easily sighted landmark, such as a light post. Use a low-power eyepiece, such as the supplied 26mm. This procedure assumes that you have some familiarity with Autostar's menu structure (you will need to locate the "Setup: Telescope" menu). If necessary, refer to **AUTOSTAR'S MENUS**, page 25.

Note: For best result, perform this procedure after you have trained the drive. See page 20.

- Adjust the latitude T-handle screws (26, Fig. 1d) so that the latitude is set to 45° or higher. See Step #6, page 12, for information about setting the latitude controls.
- Refer to Fig. 48 while performing this step. The Dec. motor (B) must be positioned so that it is at the back of the mount. The optical tube (A) must be approximately horizontal (*i.e.*, parallel with the horizon) and the counterweight shaft must be pointing straight down.

If using a Schmidt-Newtonian model, loosen the cradle ring locks knobs (C) and move the optical tube until the eyepiece (D) points downward as shown in the Fig. 48. Re-tighten the cradle ring locks.

If using a refractor model, use the diagonal assembly to rotate the eyepiece to a convenient viewing angle during testing. However, be careful that the diagonal is placed flush against the focuser and tightened in place using the thumb-screws. It is important that the diagonal does not slip during the procedure.

- Make sure that both the R.A. and Dec. locks (17 and 33, Fig. 1d) are tightened to a firm feel.
- Turn on Autostar and go to "Setup: Telescope." Press ENTER.
- Press one of the Scroll keys until "LXD 55 Adjust" displays and then press ENTER. A message displays that tells you to center a landmark. If the landmark is not visible in your eyepiece, lift and move the entire telescope and tripod assembly—try not to move the tube too far from the horizontal position (no more than 5° up or down), as described in Step #2. You may also use the fine azimuth controls (27, Fig. 1d) for side to side movement and the Autostar Up/Down Arrows for small adjustments to the declination axis.
- Caution:** Before pressing ENTER, step back from the telescope assembly, as the telescope will begin to rotate about two axes. When the landmark is centered (Step #5), press ENTER.

The telescope first moves 180° on the Dec. axis and then rotates 180° on the R.A. axis. Autostar displays "Slewing...".

When the telescope has completed the 180° slew, the telescope will be under the mount instead of over it. The counterweight shaft is now pointed upwards and the cradle adjustment screws (Fig. 47) are easily accessible.

- Autostar again prompts you to center the landmark you have chosen in the eyepiece. Use the Arrow keys to center the object and then press ENTER.
- The telescope moves again on the R.A. axis. Use the cradle screw adjustment mechanism on the bottom of the cradle to center the landmark in the eyepiece.

To adjust the cradle screws, use the supplied hex key to loosen the two outside screws. Then adjust the position of the landmark by tightening or loosening the center screw. Perform this adjustment on both sets of screws. When finished, retighten the outer screws. The axis is now aligned.

Note: This procedure maximizes the pointing accuracy of the telescope provided the telescope is always placed on the mount in the same fashion. A mark made on the mount under the saddle will ensure this alignment is maintained.

Method #4: Smart Drive Training (Periodic Error Correction)

If you wish to improve the gear performance on your telescope, first, perform the train the drive procedure (see page 20). Then use the Periodic Error Correction (PEC) Train menu option to remove the slight perturbations from center that occur due to the mechanical nature of a telescope. To perform this procedure, you need to use a high-power reticle, such as the 9mm reticle (see **OPTIONAL ACCESSORIES**, page 37).

Important Note: In order for the Smart Drive training to operate and be updated properly, you must "park" the telescope (see **PARK SCOPE**, page 28).

PEC Train Menu Option

To perform the procedure on the R.A. axis, pick a bright star in the South that has minimal movement and is about 30° above the horizon (**Note:** If in the Southern hemisphere, pick a star in the North that is about 30° above the horizon).

Important Note: The Train option overwrites any previous PEC data.

- Select "PEC Train" from the Smart Drive menu (in the "Setup: Telescope" menu) and press ENTER.
- Look through the reticle. Use the Arrow keys to keep the star centered in the reticle cross-hairs. Autostar displays a count of the 150 positions of the worm gear. When the count reaches 150, one cycle is complete. A full cycle takes about 12 minutes.
- Press MODE to exit.

PEC Update Menu Option

PEC Update does not overwrite the data, but updates the training using information gathered from both the last and the current training sessions. Press the MODE key to exit from this option. If you wish to further refine your training, select this menu again and repeat the procedure.

PEC Erase Menu Option

Select this option to erase all PEC training data.

APPENDIX C: LATITUDE CHART

Latitude Chart for Major Cities of the World

To aid in the polar alignment procedure (see pages 17-21), latitudes of major cities around the world are listed below. To determine the latitude of an observing site not listed on the chart, locate the city closest to your site. Then follow the procedure below:

Northern hemisphere observers (N): If the site is over 70 miles (110 km) north of the listed city, add one degree for every 70 miles. If the site is over 70 miles South of the listed city, subtract one degree per 70 miles.

Southern Hemisphere observers (S): If the site is over 70 miles (110 km) north of the listed city, subtract one degree for every 70 miles. If the site is over 70 miles South of the listed city, add one degree per 70 miles.

NORTH AMERICA			SOUTH AMERICA		
City	State/Prov./Country	Latitude	City	Country	Latitude
Albuquerque	New Mexico	35° N	Bogotá	Colombia	4° N
Anchorage	Alaska	61° N	São Paulo	Brazil	23° S
Atlanta	Georgia	34° N	Buenos Aires	Argentina	35° S
Boston	Massachusetts	42° N	Montevideo	Uruguay	35° S
Calgary	Alberta	51° N	Santiago	Chile	34° S
Chicago	Illinois	42° N	Caracas	Venezuela	10° N
Cleveland	Ohio	41° N			
Dallas	Texas	33° N	ASIA		
Denver	Colorado	40° N	City	Country	Latitude
Detroit	Michigan	42° N	Beijing	China	40° N
Honolulu	Hawaii	21° N	Hong Kong	China	23° N
Jackson	Mississippi	32° N	Seoul	South Korea	37° N
Kansas City	Missouri	39° N	Taipei	Taiwan	25° N
Kenosha	Wisconsin	45° N	Tokyo	Japan	36° N
Las Vegas	Nevada	36° N	Sapporo	Japan	43° N
Little Rock	Arkansas	35° N	Bombay	India	19° N
Los Angeles	California	34° N	Calcutta	India	22° N
Mexico City	Mexico	19° N	Hanoi	Vietnam	21° N
Miami	Florida	26° N	Jedda	Saudi Arabia	21° N
Minneapolis	Minnesota	45° N	AFRICA		
Nashville	Tennessee	36° N	City	Country	Latitude
New Orleans	Louisiana	30° N	Cairo	Egypt	30° N
New York	New York	41° N	Cape Town	South Africa	34° S
Oklahoma City	Oklahoma	35° N	Rabat	Morocco	34° N
Ottawa	Ontario	45° N	Tunis	Tunisia	37° N
Philadelphia	Pennsylvania	40° N	Windhoek	Namibia	23° S
Phoenix	Arizona	33° N	AUSTRALIA AND OCEANIA		
Portland	Oregon	46° N	City	State/Country	Latitude
Salt Lake City	Utah	41° N	Adelaide	South Australia	35° S
San Antonio	Texas	29° N	Brisbane	Queensland	27° S
San Diego	California	33° N	Canberra	New South Wales	35° S
San Francisco	California	38° N	Alice Springs	Northern Territory	24° S
Seattle	Washington	47° N	Hobart	Tasmania	43° S
Washington	District of Columbia	39° N	Perth	Western Australia	32° S
			Sydney	New South Wales	34° S
			Melbourne	Victoria	38° S
			Auckland	New Zealand	37° S
EUROPE					
City	Country	Latitude			
Amsterdam	Netherlands	52° N			
Athens	Greece	38° N			
Bern	Switzerland	47° N			
Copenhagen	Denmark	56° N			
Dublin	Ireland	53° N			
Frankfurt	Germany	50° N			
Glasgow	Scotland	56° N			
Helsinki	Finland	60° N			
Lisbon	Portugal	39° N			
London	England	51° N			
Madrid	Spain	40° N			
Oslo	Norway	60° N			
Paris	France	49° N			
Rome	Italy	42° N			
Stockholm	Sweden	59° N			
Vienna	Austria	48° N			
Warsaw	Poland	52° N			

Important Note:
The Electronic Controllers available for Meade's ETX and DS telescope series are not compatible and will not operate with the LX D75 EC series models. Do not plug in other telescope series' EC handboxes into the LX D75 computer control panel, nor plug the LX D75 EC series handboxes into any other telescope series computer control panel.

Light No.	Light Status
● Light 1	● On
● Light 2	⚡ Blinking
● Light 3	○ Off
● Light 4	○ Off

Fig 50: Indicator Light Key. The procedures in this manual identify the status of the four indicator lights as depicted above: on, blinking, or off.

APPENDIX D: EC HANDBOX

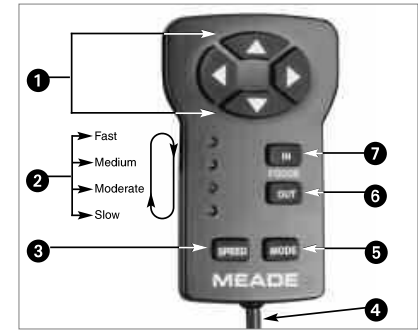

Fig. 49: Electronic Controller. (1) Arrow Keys; (2) Indicator Lights; (3) SPEED Key; (4) Coil Cord; (5) MODE Key; (6) OUT Key; (7) IN Key.

Some LX D75 models (designated with an "EC," for example, AR-5EC) come equipped with an Electronic Controller (EC) handbox, rather than the Autostar Handbox. The Electronic Controller provides you with the means to control the telescope motors from a compact handbox. The Electronic Controller (Fig. 49) has soft-touch keys designed to have a positive feel, even through gloves.

The primary functions of the Electronic Controller are to move (slew) the telescope to an object, to set operation for the Northern or Southern Hemispheres, and to indicate the slew speed.

Users of the EC models should follow the procedures described in **GETTING STARTED**, **BALANCING THE TELESCOPE**, **ALIGNING THE VIEWFINDER**, **CHOOSING AN EYEPIECE**, and **OBSERVING BY MOVING THE TELESCOPE MANUALLY**, pages 11 - 16. Other sections relevant to EC users include: **OBSERVE THE MOON** and **SETTING POLAR HOME POSITION**, page 17, and **PHOTOGRAPHY, OPTIONAL ACCESSORIES, GENERAL MAINTENANCE, SPECIFICATIONS**, and **CELESTIAL COORDINATES**, pages 36 - 39 and 46 - 51. **LATITUDE CHARTS**, page 57, and **BASIC ASTRONOMY**, pages 63 - 64, may also be useful. Note that **SLEW SPEEDS**, page 16, refers to Autostar functions only. Slew speed functions of the Electronic Controller are covered in this appendix.

The following numbers refer to Fig. 49 above.

1 Arrow Keys: Press one of the four Arrow keys to slew the telescope (i.e., up, down, left, and right) at any one of four slew speeds (see **SPEED KEY** below).

Important Note: If you reverse directions while using the Arrow keys to slew to objects, there may be a slight pause as the telescope motors compensate for the reversal of the internal gears.

2 Indicator Lights: The four red LED (Light Emitting Diode) lights indicate the current slew speed of the telescope.

Note: For purposes of this manual, the lights are identified as 1 through 4, with 1 being the top light and 4 being the bottom light.

3 SPEED Key: Press **SPEED** to change the speed at which the telescope slews to an object. Each press of the **SPEED** key changes the slew speed to the next slower setting. If the controller is already on the slowest slew speed (light 4), pressing **SPEED** cycles back to the highest speed (light 1). Slew speeds are signified by the indicator lights (2, Fig. 49).

4 Coil Cord: Plug into the HBX connector of the Computer Control Panel.

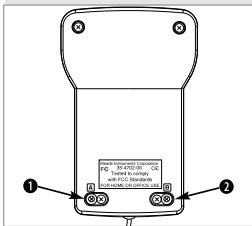

Fig. 51: Mode screws on rear of Electronic Controller. (1) Mode Screw A; (2) Mode Screw B.

Definition: Sidereal.
As the Earth rotates beneath the night sky, the stars appear to move from East to West. The speed at which the stars move is called the sidereal rate. You can setup your telescope to move at the sidereal rate so that it automatically tracks the stars and other objects in the night sky. The tracking function automatically keeps an object more or less centered in the telescope's eyepiece.

See pages 17 and 18 for more information.

- 5. **MODE Key:** Press and hold MODE to place the Electronic Controller into the Mode function, i.e., to select operation for the Northern or Southern Hemisphere. See **TRACKING RATES**, page 60.
- 6. **OUT Key:** Use this key to decrease the tracking rate. See **TRACKING RATES**, page 60.
- 7. **IN Key:** Use this key to increase the tracking rate. See **TRACKING RATES**, page 60.

Modes of Operation

- When both the A and B screws are in place, the *Northern hemisphere polar* mode is selected when power is applied (i.e., the motor drive is activated for operation in the Earth's Northern Hemisphere). This is the factory default mode.
- Remove mode screw B (2, Fig. 51) to make the *Southern Hemisphere polar* mode the automatic default of the Electronic Controller when power is applied (i.e., the motor drive is activated for operation in the Earth's Southern Hemisphere).
- Remove mode screw A to disable the tracking function. Select either the Northern hemisphere polar mode or the Southern Hemisphere polar mode, as described above, to make the tracking function available. See **CHANGING THE POLAR MODE**, page 61, for more information.

Note: Removing either A or B screw affects only the telescope's default mode; you may still make mode changes when desired using the MODE key.

Slew Speeds

The Electronic Controller has four slew speeds that are directly proportional to the sidereal rate. Press SPEED to change the slew speed (use the Arrow keys to slew the telescope in the desired direction). Note each slew speed corresponds to one of the four LED's of the Electronic Controller.

Light 1 (top LED): The fastest speed. Use to move the telescope quickly from one point in the sky to another.

Light 2: Best for centering an object in the viewfinder.

Light 3: Best for centering an object in the field of a low-to-moderate power eyepiece, such as the standard SP 26mm.

Light 4: The slowest speed. Use to center an object in the field of view of high-power eyepieces, such as the optional 6.7mm or 12.4mm.

The four available speeds are:

- Light 1 = 1200 x sidereal (300 arc-min/sec or 5°/sec)
- Light 2 = 32 x sidereal (8 arc-min/sec)
- Light 3 = 8 x sidereal (2 arc-min/sec)
- Light 4 = 2 x sidereal (0.5 arc-min/sec)

The two slowest speeds (2x and 8x sidereal) can be used for manual tracking of astronomical objects while observing through the eyepiece.

To move the telescope using the Electronic Controller:

1. Insert a low-power eyepiece (e.g., SP 26mm) into the eyepiece holder (2, Fig. 1) and tighten the eyepiece thumbscrew (1, Fig. 1).
2. Tighten the R.A. and Dec. locks (17 and 33, Fig. 1), if necessary.
3. Verify that the On/Off switch (24D, Fig. 1) on the telescope's Computer Control panel is off.
4. Plug in the Electronic Controller coil cord (4, Fig. 49) to the HBX port (24A, Fig. 1) on the Computer Control panel.
5. Flip the power switch to ON. The LED (24C, Fig. 1) on the Computer Control panel lights. The Speed indicators lights will cycle off and on in sequence.
6. Press any key on the Electronic Controller and the telescope slews momentarily in the vertical and horizontal directions to test the motors.

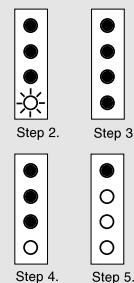

Fig. 52a: Indicator Light Key for changing tracking rates in the Northern Hemisphere Polar mode.

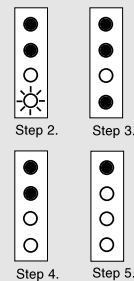

Fig. 52b: Indicator Light Key for changing tracking rates in the Southern Hemisphere Polar mode.

7. When the test is complete, light 1 remains on; lights 2, 3, and 4 turn off.
8. Use the four Arrow keys (1, Fig. 49) to slew the telescope to the desired object. To change the slew speed, press SPEED.
9. Fine-adjust the position of the object with the Electronic Controller Arrow keys so that it is centered in the viewfinder. The object is now ready to be viewed through the telescope's eyepiece.

Tracking Rates

In polar mode the Electronic Controller normally tracks objects at the sidereal rate (see **TRACKING OBJECTS**, page 17). For most observing sessions (once the telescope has been polar aligned and the tracking motor activated), there is little need to change this speed.

For objects, like the Moon or a comet, that move at slightly different rates, the Electronic Controller Arrow keys (1, Fig. 49) are sufficient to move the telescope slightly as the object very slowly moves off-center through the eyepiece field.

To change the tracking rate, for extended observations of an object not moving at the sidereal rate, follow the procedure for the appropriate hemisphere:

Use the following procedure to change tracking rates when using the Northern Hemisphere polar mode. Refer to Fig. 52a.

1. Press and hold MODE (5, Fig. 49) until the Mode function is active (i.e., lights 1 and 2 are on steady; lights 3 and 4 signify whatever tracking mode was last chosen).
2. Press SPEED (3, Fig. 49) until lights 1, 2, and 3 are on steady with light 4 blinking. The telescope is now in the Northern Hemisphere polar mode.
3. Press IN (7, Fig. 49) and light 4 comes on steady. The tracking rate is now 0.5% faster than sidereal. If the object you're tracking is moving faster than the sidereal rate, look through the eyepiece and press IN. Each time you press IN, the tracking rate increases by 0.5%. **Note that when the Mode function is active, the tracking motor stops. To restart the tracking motor, press MODE again.** Experiment with this function to get the right speed: Press IN to set the tracking rate. Then press MODE and look through the eyepiece. Continue pressing IN and MODE until the object remains centered with little or no drifting in the eyepiece.

Note: The tracking rate can be increased by up to 65%.

4. To use a rate slower than sidereal, press OUT (6, Fig. 49) until light 4 blinks again (sidereal rate). Press OUT again and light 4 goes out, signifying a tracking rate 0.5% slower than sidereal. **Note that when the Mode function is active, the tracking motor stops. To restart the tracking motor, press MODE again.** Experiment with this function to get the right speed: Press OUT to set the tracking rate. Then press MODE and look through the eyepiece. Continue pressing OUT and MODE until the object remains centered with little or no drifting in the eyepiece.

Note: The tracking rate can be decreased by up to 65%.

5. Press and hold MODE until only a single light is on. This exits the Mode function. If Northern or Southern Hemisphere polar mode was chosen, the motor drive starts operating at the sidereal rate.
6. Use the four Arrow keys (1, Fig. 49) to slew the telescope to the desired object. To change the slew speed, press SPEED.

Use the following procedure to change tracking rates when using the Southern Hemisphere polar mode. Refer to Fig. 52b.

1. Press and hold MODE (5, Fig. 49) until the Mode function is active (i.e., lights 1 and 2 are on steady; lights 3 and 4 signify the tracking mode last chosen).
2. Press SPEED (3, Fig. 49) until lights 1 and 2 are on steady, light 3 is off, and Light 4 is blinking.
3. Press IN (7, Fig. 49) and light 4 comes on steady. The tracking rate is now 0.5% faster than sidereal. **Note that when the Mode function is active, the tracking motor stops. To restart the tracking motor, press MODE again.** Experiment with this function to get the right speed: Press IN to set the tracking rate. Then press MODE and look through the eyepiece. Continue pressing IN and MODE until the object remains centered with little or no drifting in the eyepiece.

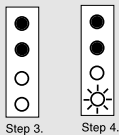

Step 3. Step 4.

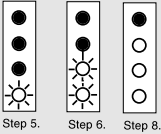

Step 5. Step 6. Step 8.

Fig. 53: Indicator Light Key for Changing the Polar Mode.

Note: The tracking rate can be increased by up to 65%.

- To use a rate slower than sidereal, press OUT (6, Fig. 49) until light 4 blinks again (sidereal rate). Press OUT key and light 4 goes out, signifying a tracking rate 0.5% slower than sidereal. **Note that when the Mode function is active, the tracking motor stops. To restart the tracking motor, press MODE again.** Experiment with this function to get the right speed: Press OUT to set the tracking rate. Then press MODE and look through the eyepiece. Continue pressing OUT and MODE until the object remains centered with little or no drifting in the eyepiece.

Note: The tracking rate can be decreased by up to 65%.

- Press and hold MODE until only a single light is on. This exits the Mode function. If Northern or Southern Hemisphere polar mode was chosen, the motor drive starts operating at the sidereal rate.
- Use the four Arrow keys (1, Fig. 49) to slew the telescope to the desired object. To change the slow speed, press SPEED.

Changing the Polar Mode

To use the Electronic Controller to change to Northern or Southern Hemisphere polar mode, use the following procedure. This procedure also allows you to select a "Tracking Disabled" setting. Refer to Fig. 53.

- Complete the **SETTING THE POLAR HOME POSITION** procedure, described on page 17.
- Complete steps 2 through 8 as described in **TO MOVE THE TELESCOPE USING THE ELECTRONIC CONTROLLER**, page 59, to initialize the Electronic Controller.
- Press and hold MODE until lights 1 and 2 are on steady ignore lights 3 and 4; they may or may not appear as depicted in the figures to the left (how these lights appear depend upon what has previously has been set).
- Press SPEED once. This changes the system to polar mode for the Earth's Southern Hemisphere, with the motor drive set to operate at the sidereal rate.
- Press SPEED a second time. This changes the system to polar mode for the Earth's Northern Hemisphere, with the motor drive set to operate at the sidereal rate.
- Press SPEED a third time to disable tracking.
- Use the SPEED key as described in the above steps to cycle among these three modes (Southern Hemisphere polar, Northern Hemisphere-polar, or Tracking Disabled) until the desired mode is shown by the appropriate light configuration.
- Press and hold MODE until just one light is on. This exits the Mode function. If you choose Northern or Southern Hemisphere polar mode, the motor drive starts operating at the sidereal rate.
- Use the four Arrow keys to slew the telescope to the desired object. To change the slow speed, press SPEED.

Optional Autostar™ Computer Controller for LX D75 EC Users

One of the most important advances in telescope control in the past 25 years, the Meade Autostar Computer Controller turns your LX D75 EC model into an automatic celestial object locating system. Just plug Autostar into the telescope's HBX port in place of the standard-equipment Electronic Controller, do a quick telescope alignment, and you are ready to observe any object in the Autostar's 30,000-object database.

Best of all, the Meade Autostar is easy to use. Even the most novice observer will locate dozens of fascinating celestial objects the very first night out. Study Saturn and its ring system; the primary cloud belts of Jupiter as well as its four major satellites; the moon-like phases of Mercury and Venus; prominent features on Mars. The Moon stands out in stark, almost three-dimensional detail—craters, mountain ranges, and fault lines. In our galaxy, the telescope displays hundreds of nebulae, star clusters, double and multiple stars, and variable stars—plus dozens of external galaxies in all their variation of form and structure.

Any of Autostar's database objects can be called up and entered on the hand controller display in seconds. The observer then simply presses the GO TO pushbutton and watches as the telescope automatically slews to the object and places it in the field of view. Autostar moves the telescope to automatically track (follow) the object across the sky. Autostar brings into easy access objects that were previously unreachable for all but the most dedicated of amateur astronomers.

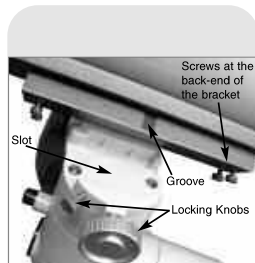

Fig. 54 Mounting the SC bracket and optical tube to the mount.

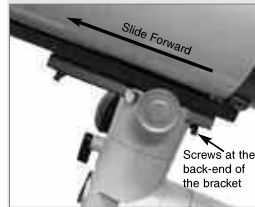

Fig. 55: Adjusting the balance of the optical tube when using heavy accessories.

APPENDIX E: MOUNTING THE MODEL SC-8 SCHMIDT-CASSEGRAIN OPTICAL TUBE

How to Attach the Optical Tube to the Mount

The LX D75 model SC-8 Schmidt-Cassegrain assembles and operates identically to all the other LX D75 models equipped with an Autostar handbox, with one exception: the optical tube is attached to the mount with a **mounting bracket** rather than the cradle ring assembly. The optical tube is shipped with the mounting bracket already attached. To attach the mounting bracket /optical tube assembly to the mount, perform the following steps.

- Perform steps 1 through 6 as described in **HOW TO ASSEMBLE YOUR TELESCOPE**, pages 11 and 12.
- Slide the mounting bracket into the cradle assembly mounting slot. For most applications, set the groove in the bracket next to the cradle locking knob, so that the bolt of the cradle locking knob will enter the groove when the knob is tightened. Tighten both the cradle locking knob and the secondary locking knob to a firm feel. See Fig. 54.

If you are using heavy accessories (such as a camera, microfocus, etc.) on the back end of the tube, you may need to balance the tube differently to keep the tube from drifting downward: Slide the mounting bracket and tube forward, until the screws at the back end of the tray touch the mount. See Figs. 54 and 55. Then tighten the cradle locking knob and the secondary locking knob to a firm feel.

- Continue the assembly with step 9 as described in **HOW TO ASSEMBLE YOUR TELESCOPE**, page 12, and complete all the subsequent steps. All other procedures are identical as described earlier in this manual.

APPENDIX F: BASIC ASTRONOMY

In the early 17th century Italian Scientist Galileo, using a telescope smaller than your LX D75, turned it skyward instead of looking at the distant trees and mountains. What he saw, and what he realized about what he saw, has forever changed the way mankind thinks about the universe. Imagine what it must have been like being the first human to see moons revolve around the planet Jupiter or to see the changing phases of Venus! Because of his observations, Galileo correctly realized Earth's movement and position around the Sun, and in doing so, gave birth to modern astronomy. Yet Galileo's telescope was so crude, he could not clearly make out the rings of Saturn.

Galileo's discoveries laid the foundation for understanding the motion and nature of the planets, stars, and galaxies. Building on his foundation, Henrietta Leavitt determined how to measure the distance to stars. Edwin Hubble gave us a glimpse into the possible origin of the universe, Albert Einstein unraveled the crucial relationship of time and light, and 21st-century astronomers are currently discovering planets around stars outside our solar system. Almost daily, using sophisticated successors to Galileo's telescope, such as the Hubble Space Telescope and the Chandra X-Ray Telescope, more and more mysteries of the universe are being probed and understood. We are living in the golden age of astronomy.

Unlike other sciences, astronomy welcomes contributions from amateurs. Much of the knowledge we have on subjects such as comets, meteor showers, double and variable stars, the Moon, and our solar system comes from observations made by amateur astronomers. So as you look through your Meade LX D75-Series telescope, keep in mind Galileo. To him, a telescope was not merely a machine made of glass and metal, but something far more—a window of incredible discovery. Each glimpse offers a potential secret waiting to be revealed.

Autostar Glossary

Be sure to make use of Autostar's Glossary feature. The Glossary menu provides an alphabetical listing of definitions and descriptions of common astronomical terms. Access directly through the Glossary menu or through hypertext words embedded in Autostar. See **GLOSSARY MENU**, page 27, for more information.

Objects in Space

Listed below are some of the many astronomical objects that can be seen with your LX D75-Series telescope:

The Moon

The Moon is, on average, a distance of 239,000 miles (380,000km) from Earth and is best observed during its crescent or half phase when Sunlight strikes the Moon's surface at an angle. It casts shadows and adds a sense of depth to the view (Fig. 56). No shadows are seen during a full Moon, causing the overly bright Moon to appear flat and rather uninteresting through the telescope. Be sure to use a neutral Moon filter when observing the Moon. Not only does it protect your eyes from the bright glare of the Moon, but it also helps enhance contrast, providing a more dramatic image.

Using your LX D75-Series telescope, brilliant detail can be observed on the Moon, including hundreds of lunar craters and maria, described below.

Craters are round meteor impact sites covering most of the Moon's surface. With no atmosphere on the Moon, no weather conditions exist, so the only erosive force is meteor strikes. Under these conditions, lunar craters can last for millions of years.

Maria (plural for mare) are smooth, dark areas scattered across the lunar surface. These dark areas are large ancient impact basins that were filled with lava from the interior of the Moon by the depth and force of a meteor or comet impact.

Twelve Apollo astronauts left their bootprints on the Moon in the late 1960's and early 1970's. However, no telescope on Earth is able to see these footprints or any other artifacts. In fact, the smallest lunar features that may be seen with the largest telescope on Earth are about one-half mile across.



Fig. 56 The Moon. Note the deep shadows in the craters.



Fig. 57: The giant planet, Jupiter. The four largest moons can be observed in a different position every night.



Fig. 58: Saturn has the most extensive ring structure in our Solar System.



Fig. 59: The Pleiades is one of the most beautiful open clusters.

Planets

Planets change positions in the sky as they orbit around the Sun. To locate the planets on a given day or month, consult a monthly astronomy magazine, such as *Sky and Telescope* or *Astronomy*. You can also consult Autostar for information about planets. Scroll to the "Object: Solar System" menu and scroll through the lists of planets. When a planet you are interested in displays, press ENTER. Use the Scroll keys to display information about the planet, such as the planet's coordinates, and the rise and set times (**Tip**: enter a date in the Date menu and you can determine if a planet(s) will be visible during the night of the entered date by checking its rise and set times). Listed below are the best planets for viewing through the LX D75-Series.

Venus is about nine-tenths the diameter of Earth. As Venus orbits the Sun, observers can see it go through phases (crescent, half, and full) much like those of the Moon. The disk of Venus appears white as Sunlight is reflected off the thick cloud cover that completely obscures any surface detail.

Mars is about half the diameter of Earth, and appears through the telescope as a tiny reddish-orange disk. It may be possible to see a hint of white at one of the planet's Polar ice caps. Approximately every two years, when Mars is closest to Earth in its orbit, additional detail and coloring on the planet's surface may be visible.

Jupiter is the largest planet in our solar system and is eleven times the diameter of Earth. The planet appears as a disk with dark lines stretching across the surface (Fig. 57). These lines are cloud bands in the atmosphere. Four of Jupiter's moons (Io, Europa, Ganymede, and Callisto) can be seen as "star-like" points of light when using even the lowest magnification. These moons orbit Jupiter so that the number of moons visible on any given night changes as they circle around the giant planet.

Saturn is nine times the diameter of Earth and appears as a small, round disk with rings extending out from either side (Fig. 58). In 1610, Galileo, the first person to observe Saturn through a telescope, did not understand that what he was seeing were rings. Instead, he believed that Saturn had "ears." Saturn's rings are composed of billions of ice particles ranging in size from a speck of dust to the size of a house. The major division in Saturn's rings, called the Cassini Division, is occasionally visible through the LX D75-Series. Titan, the largest of Saturn's moons can also be seen as a bright, star-like object near the planet.

Deep-Sky Objects

Star charts can be used to locate constellations, individual stars and deep-sky objects. Examples of various deep-sky objects are given below:

Stars are large gaseous objects that are self-illuminated by nuclear fusion in their core. Because of their vast distances from our solar system, all stars appear as pinpoints of light, irrespective of the size of the telescope used.

Nebulae are vast interstellar clouds of gas and dust where stars are formed. Most impressive of these is the Great Nebula in Orion (M42), a diffuse nebula that appears as a faint wispy gray cloud. M42 is 1600 light years from Earth.

Open Clusters are loose groupings of young stars, all recently formed from the same diffuse nebula. The Pleiades is an open cluster 410 light years away (Fig. 59). Through the LX D75-Series, numerous stars are visible.

Constellations are large, imaginary patterns of stars believed by ancient civilizations to be the celestial equivalent of objects, animals, people, or gods. These patterns are too large to be seen through a telescope. To learn the constellations, start with an easy grouping of stars, such as the Big Dipper in Ursa Major. Then, use a star chart to explore across the sky.

Galaxies are large assemblies of stars, nebulae, and star clusters that are bound by gravity. The most common shape is spiral (such as our own Milky Way), but galaxies can also be elliptical, or even irregular blobs. The Andromeda Galaxy (M31) is the closest spiral-type galaxy to our own. This galaxy appears fuzzy and cigar-shaped. It is 2.2 million light years away in the constellation Andromeda, located between the large "W" of Cassiopeia and the great square of Pegasus.

LXD75 TIPS

Further Study....

This manual gives only the briefest introduction to astronomy. If you are interested in pursuing further studies in astronomy, a few topics are suggested below that are worth reading up on. Try looking up some of these in the optional Autostar glossary. Also included below is a small sampling of books, magazines, and organizations that you might find helpful.

Topics

1. How is a star born? How does a solar system form?
2. How is the distance to a star measured? What is a light year? What is red shift and blue shift?
3. How are the craters on our Moon formed? Is there water under the surface of the Moon?
4. What is a black hole? A neutron star? A gamma burster? An Einstein lens?
5. What are stars made of? Why are stars different colors? How is the elemental composition of a star determined? What is an Lyman Alpha forest?
6. What is the difference between a Type I and a Type II supernova?
7. What is the importance of studying the composition of comets? Where do comets come from?
8. How old is our Sun? Will our Sun evolve into a planetary nebula or go super-nova?
9. What is the Inflationary Big Bang? What is dark matter? What are MACHO's?
10. How are extrasolar planets discovered? What is an accretion (or protoplanetary) disk?
11. What are the differences between elliptical, spiral, and irregular galaxies? Can globular clusters be older than the universe itself?

Books

1. [The Guide to Amateur Astronomy](#) by Jack Newton and Philip Teece
2. [The Sky: A User's Guide](#) by David Levy
3. [Turn Left at Orion](#) by Guy Consolmagno & Dan Davis
4. [Astrophotography for the Amateur](#) by Michael Covington
5. [Observing for the Fun of It](#) by Melanie Melton
6. [Will Black Holes Devour the Universe? and 100 Other Questions about Astronomy](#) by Melanie Melton

Magazines

1. *Sky & Telescope*
Box 9111, Belmont, MA 02178
2. *Astronomy*
Box 1612, Waukesha, WI 53187

Organizations:

1. Astronomical League
Executive Secretary
5675 Real del Norte, Las Cruces, NM 88012
2. The Astronomical Society of the Pacific
390 Ashton Ave., San Francisco, CA 94112
3. The Planetary Society
65 North Catalina Ave., Pasadena, CA 91106

And watch Jack Horkheimer, *Star Gazer*, on your local PBS station.



MEADE LIMITED WARRANTY

Every Meade telescope, spotting scope, and telescope accessory is warranted by Meade Instruments Corporation ("Meade") to be free of defects in materials and workmanship for a period of ONE YEAR from the date of original purchase in the U.S.A. and Canada. Meade will repair or replace a product, or part thereof, found by Meade to be defective, provided the defective part is returned to Meade, freight-prepaid, with proof of purchase. This warranty applies to the original purchaser only and is non-transferable. Meade products purchased outside North America are not included in this warranty, but are covered under separate warranties issued by Meade international distributors.

RGA Number Required: Prior to the return of any product or part, a Return Goods Authorization (RGA) number **must** be obtained from Meade by writing, or calling (949) 451-1450. Each returned part or product must include a written statement detailing the nature of the claimed defect, as well as the owner's name, address, and phone number.

This warranty is not valid in cases where the product has been abused or mishandled, where unauthorized repairs have been attempted or performed, or where depreciation of the product is due to normal wear-and-tear. Meade specifically disclaims special, indirect, or consequential damages or lost profit which may result from a breach of this warranty. Any implied warranties which cannot be disclaimed are hereby limited to a term of one year from the date of original retail purchase.

This warranty gives you specific rights. You may have other rights which vary from state to state.

Meade reserves the right to change product specifications or to discontinue products without notice.



MEADE[®]

6001 Oak Canyon, Irvine, California 92618
(949) 451-1450 ■ www.meade.com

14-7500-01 2/05C